

# DATA STRATEGY: THE PATHWAY FROM DATA TO TANGIBLE BUSINESS IMPACT

JAN MESKENS

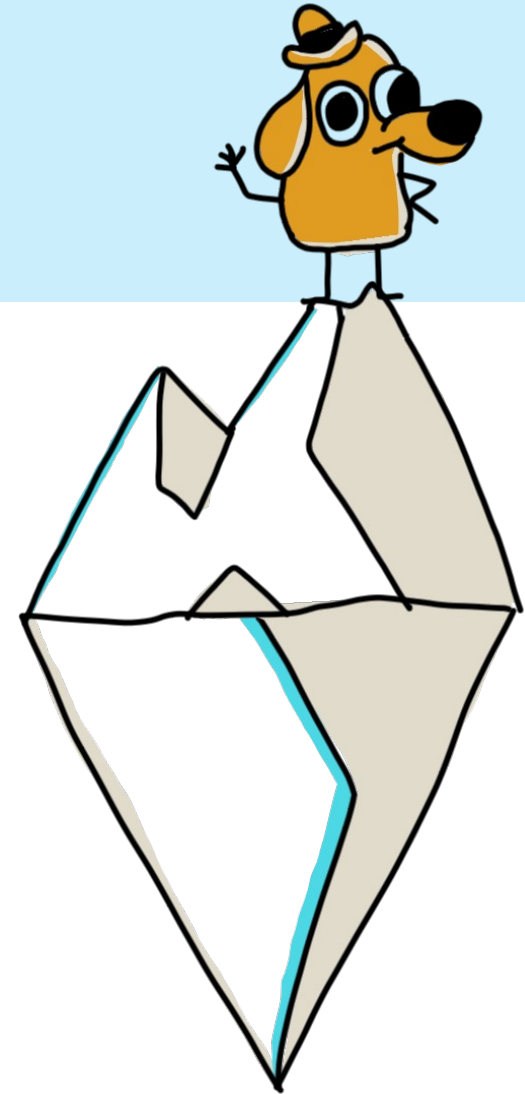

Presented for





# Jan Meskens

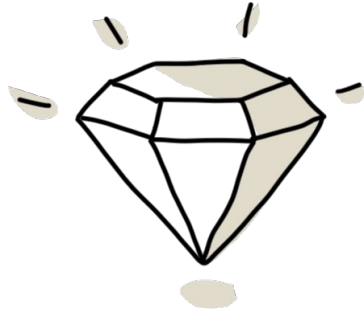

Data and AI Strategy  
Consultant

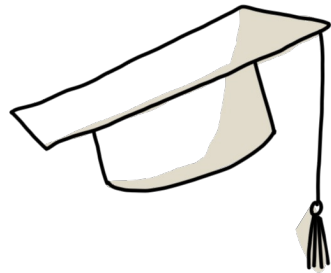

Keynote Speaker,  
Lecturer and Trainer



Founder and Manager  
of Sievax

DATA  
USE CASES

DATA  
FOUNDATIONS

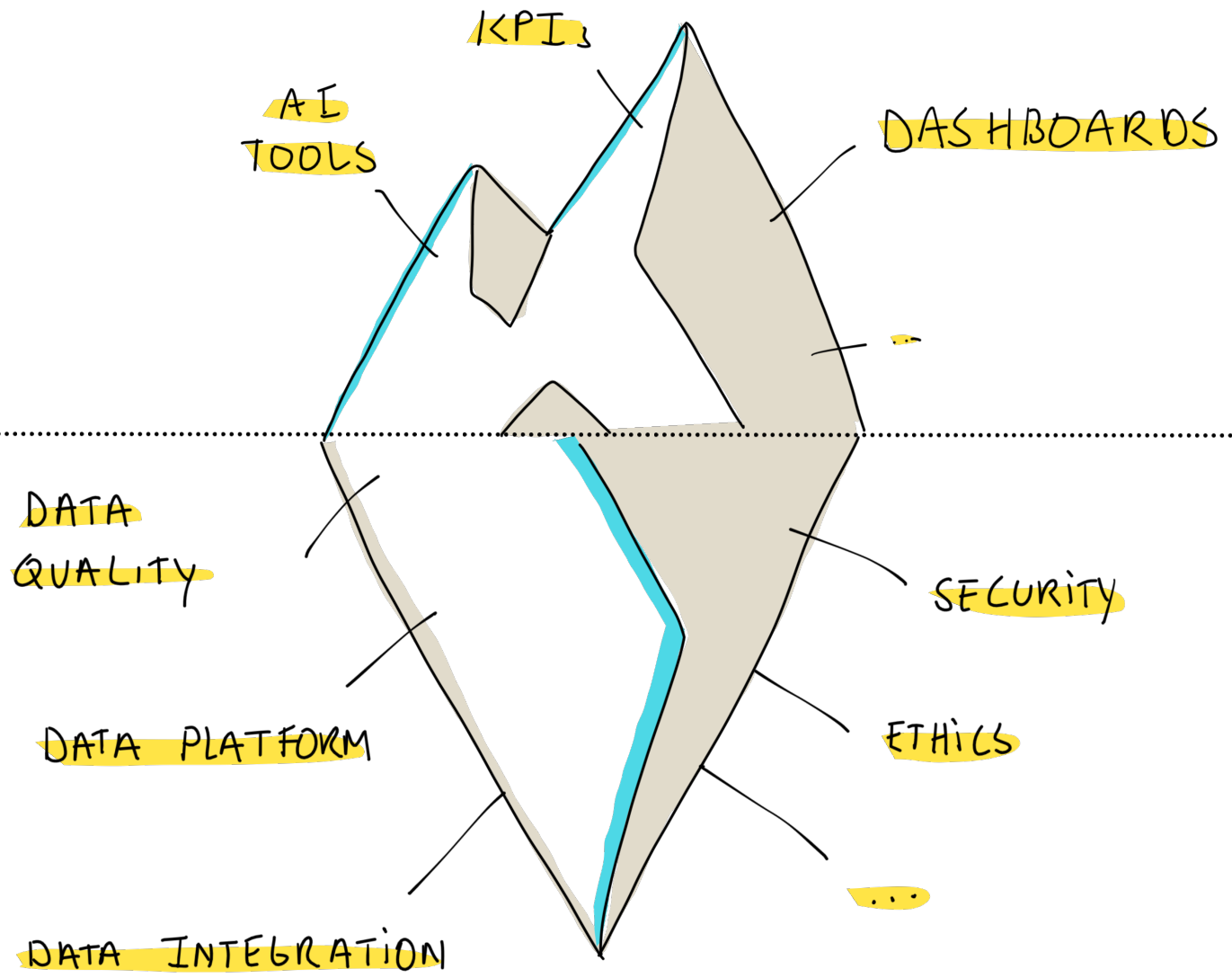

DATA

USE CASES

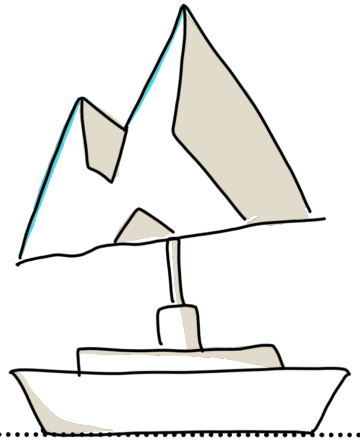

DATA

FOUNDATIONS

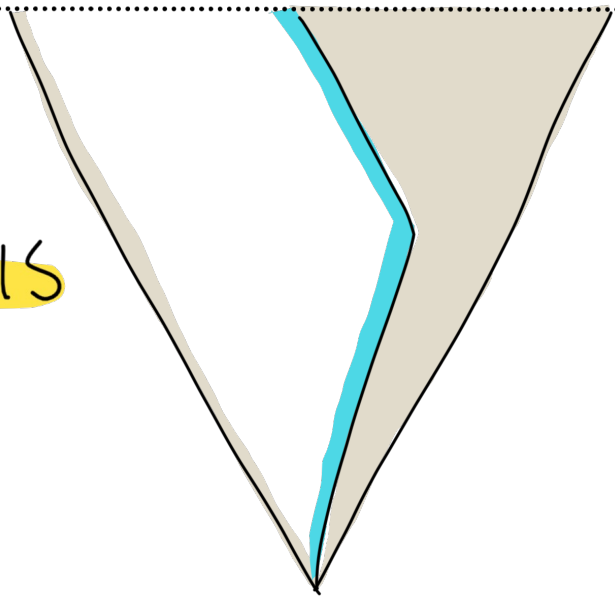

DATA  
USE CASES

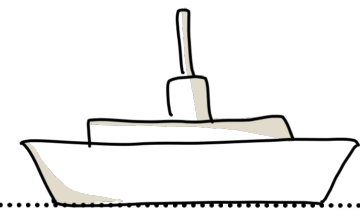
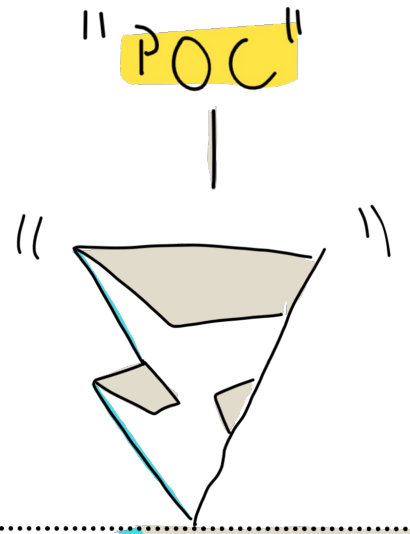

DATA  
FOUNDATIONS

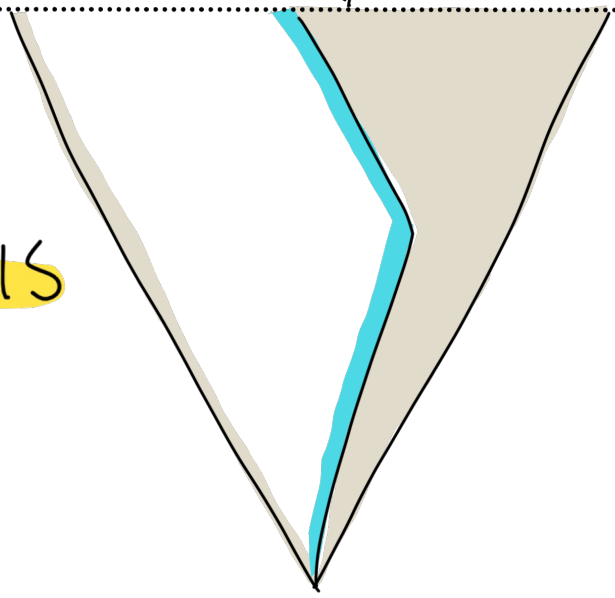

DATA

USE CASES

DATA

FOUNDATIONS

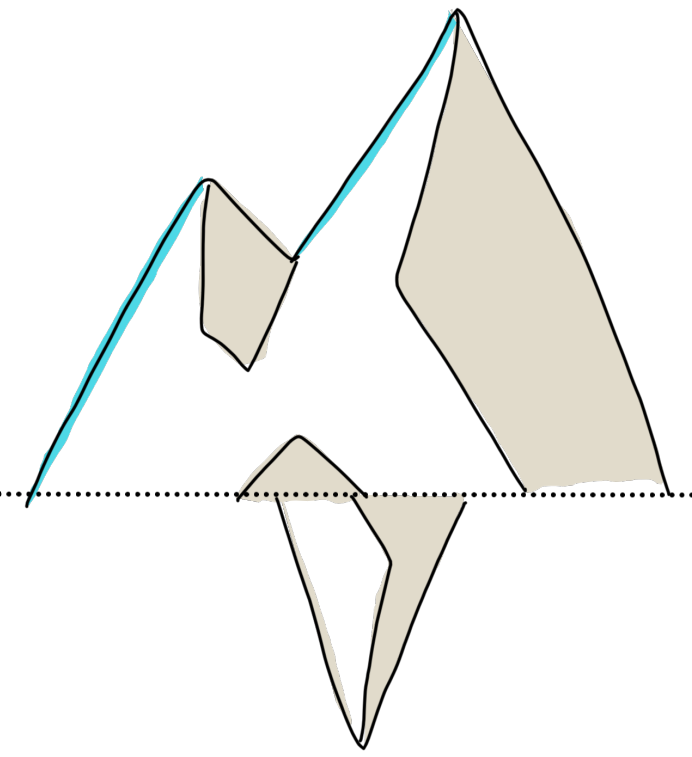
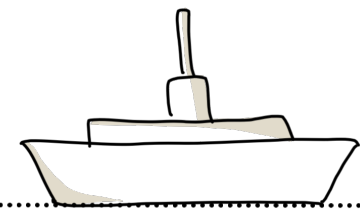
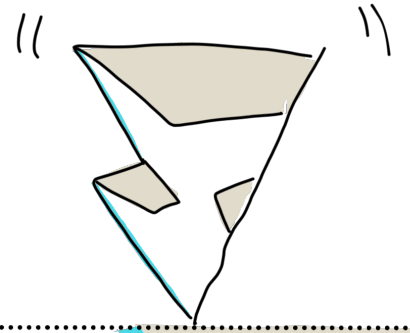

DATA  
USE CASES

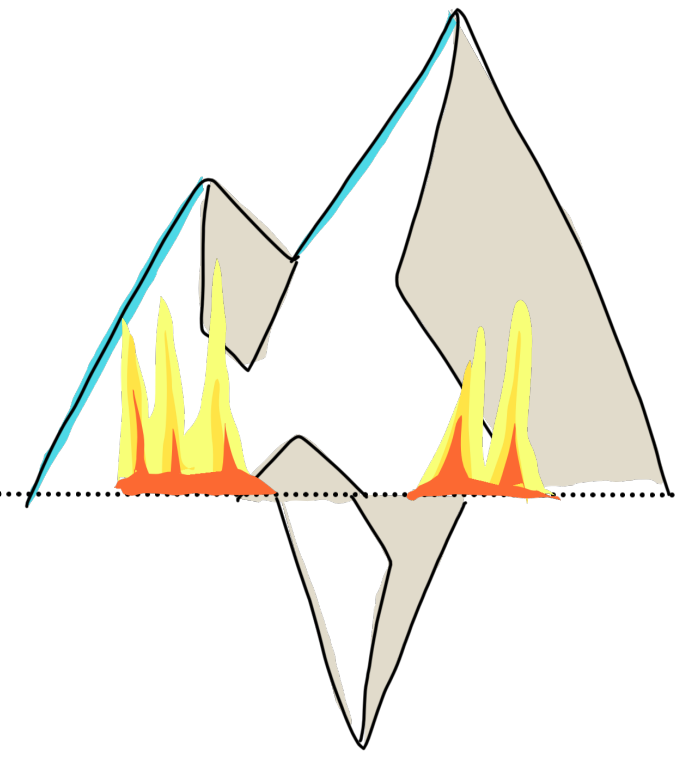
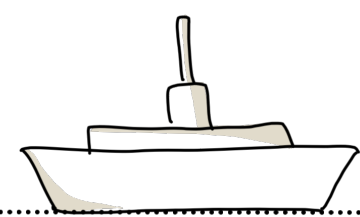
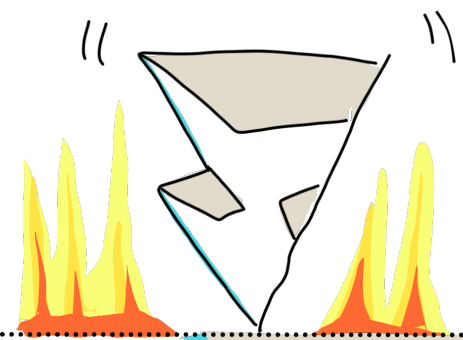

DATA  
FOUNDATIONS

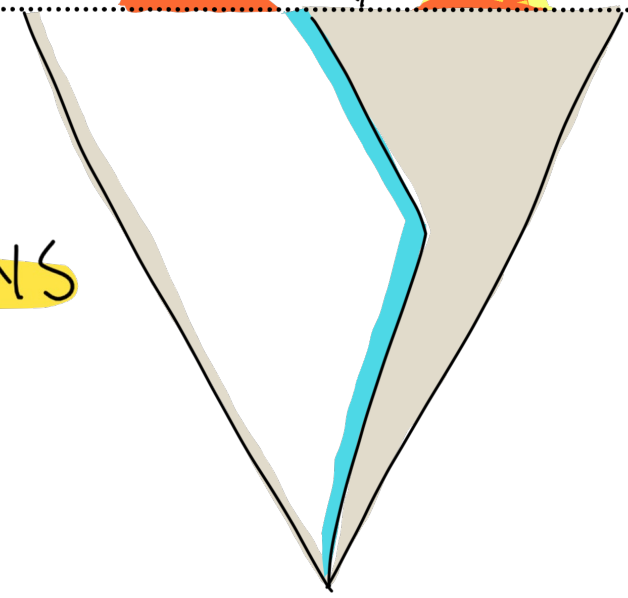

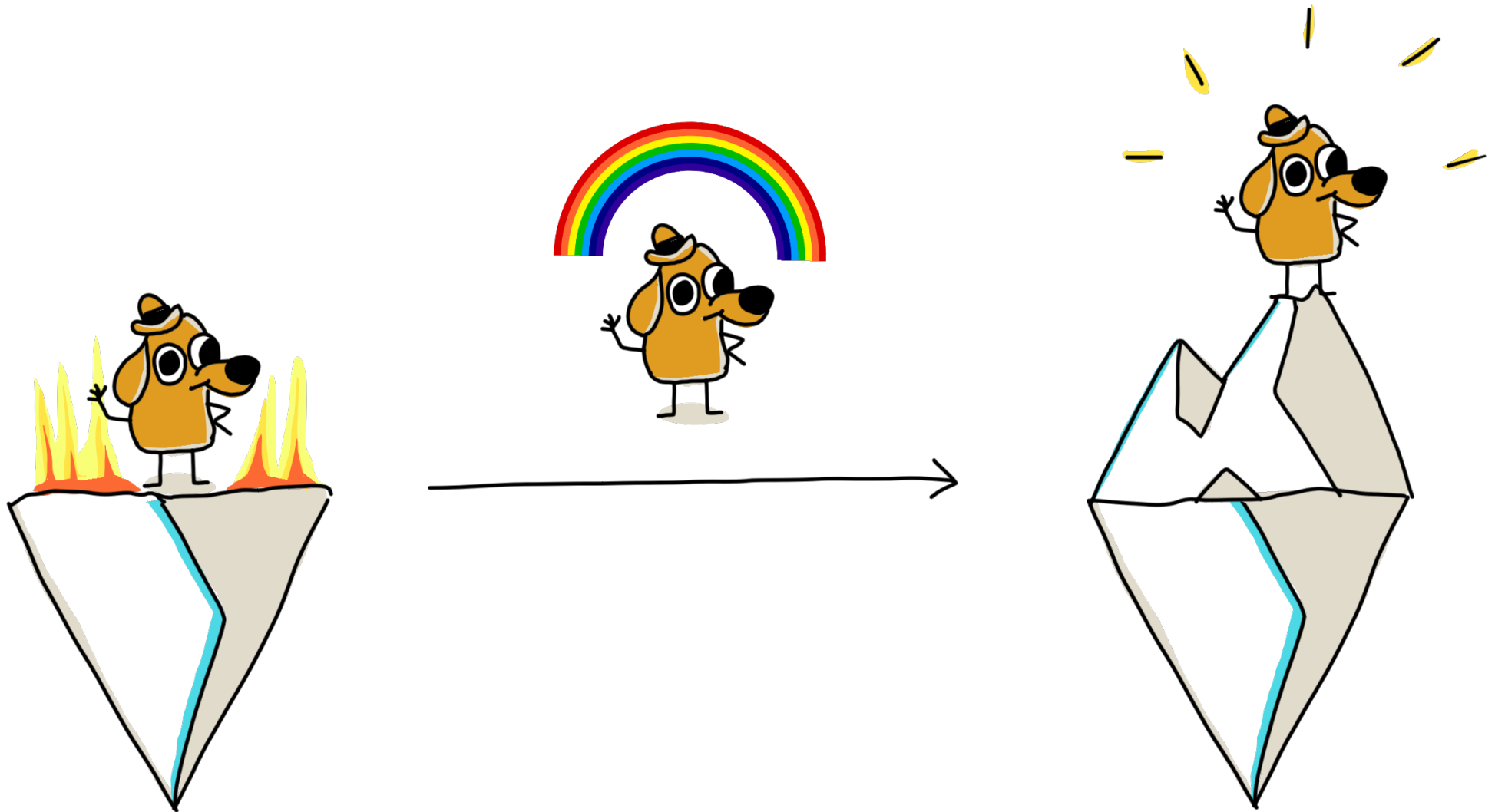

# THE DATA ENGINEERING EXPERIENCE

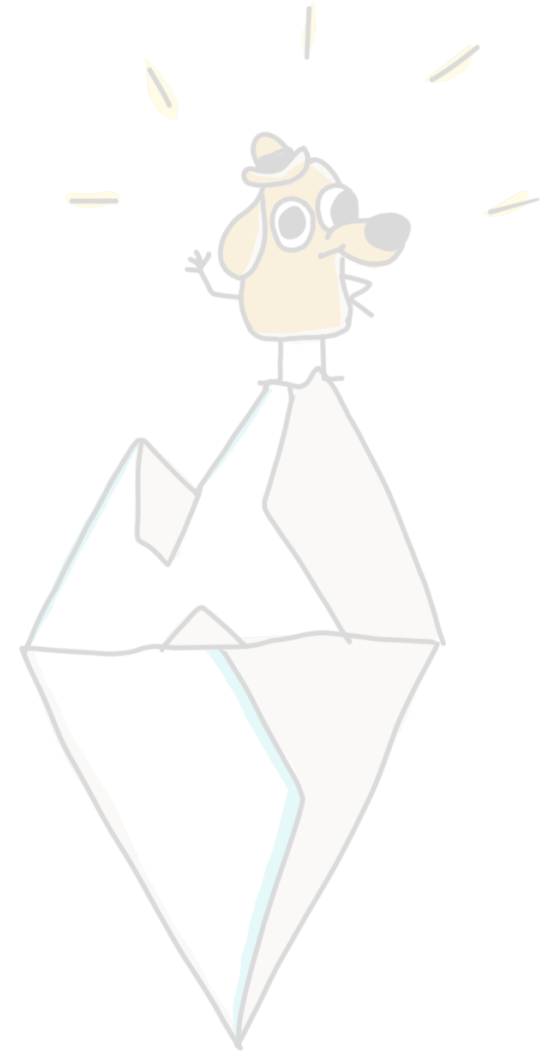

# MY IMAGINARY DATA WORLD



# MY IMAGINARY DATA WORLD



# MY IMAGINARY DATA & AI MACHINE

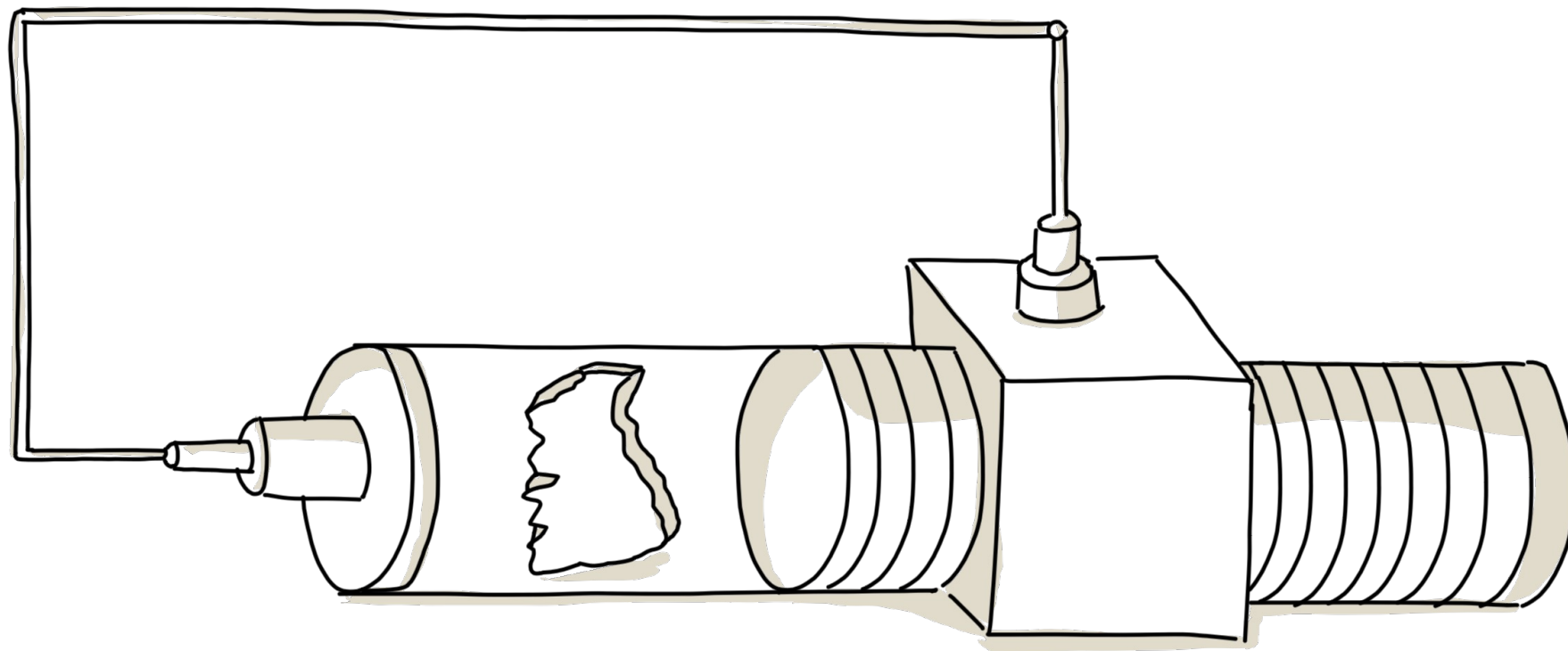

# MY IMAGINARY DATA & AI MACHINE

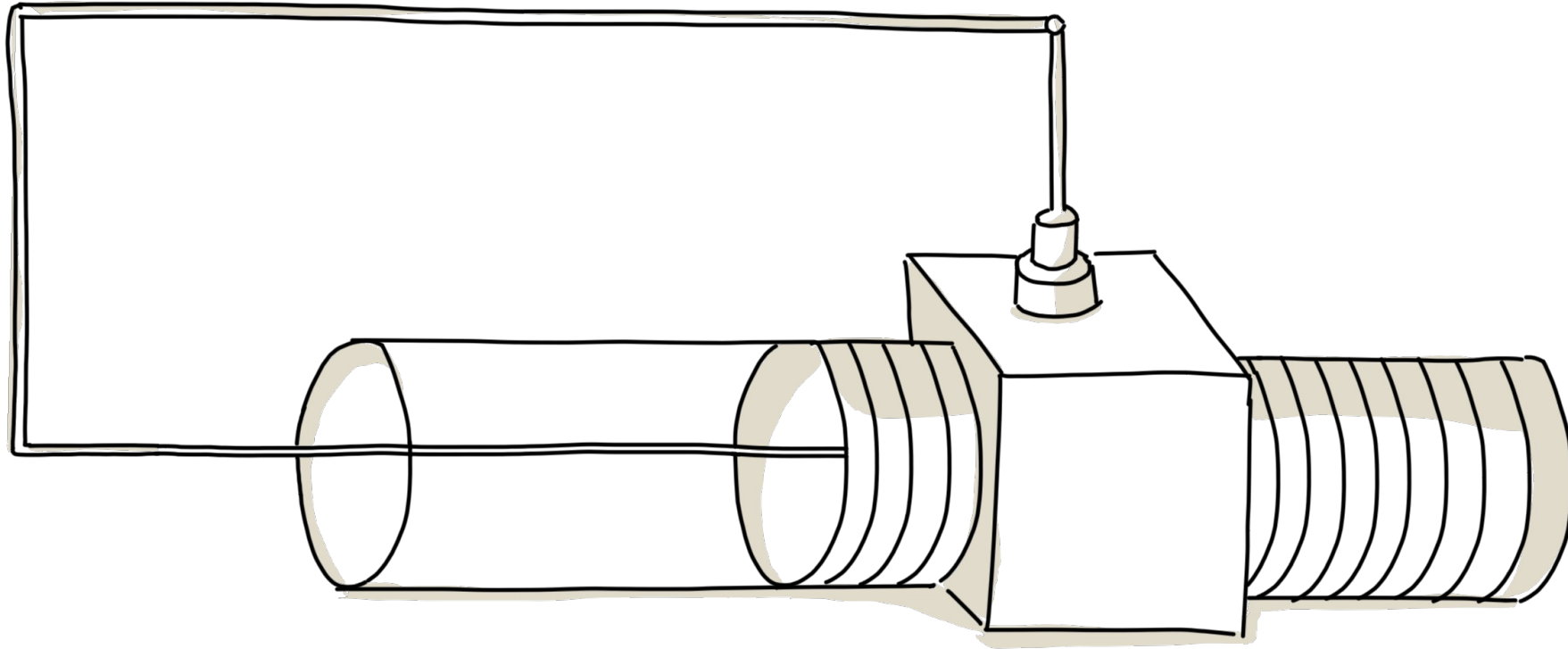

# MY IMAGINARY DATA & AI MACHINE

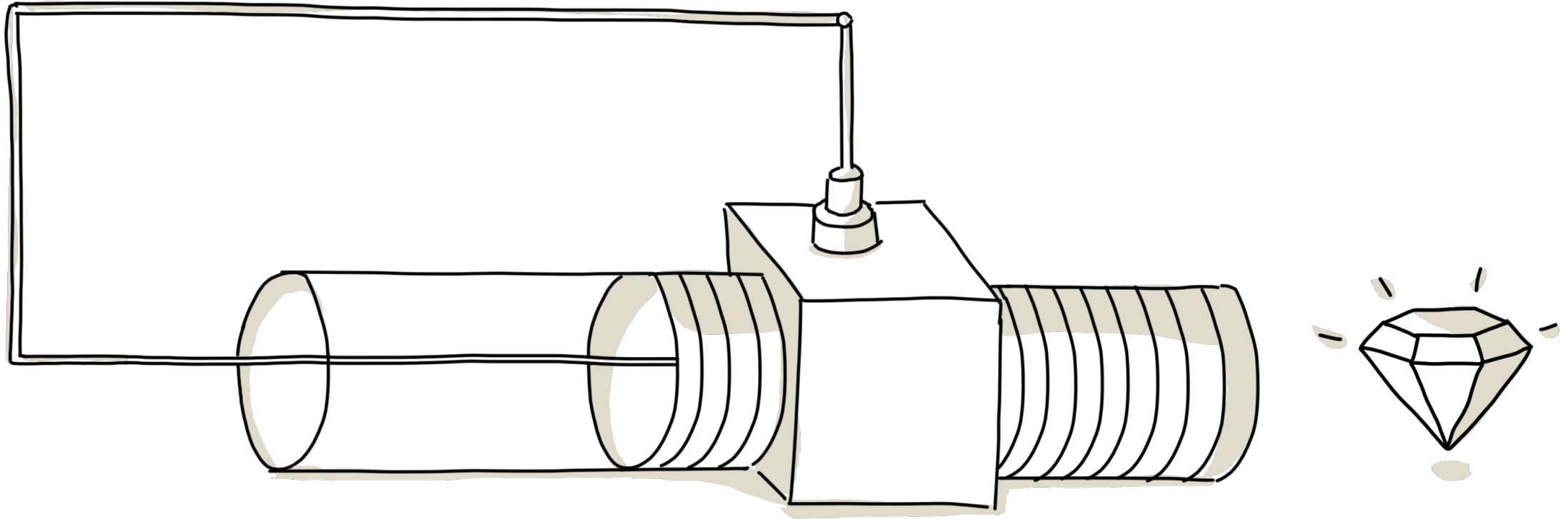

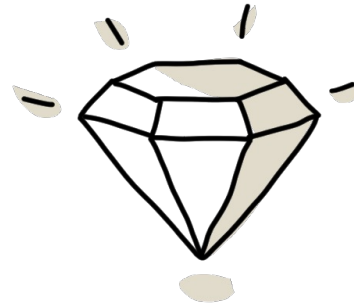
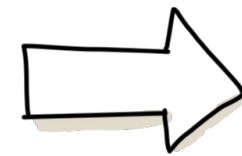
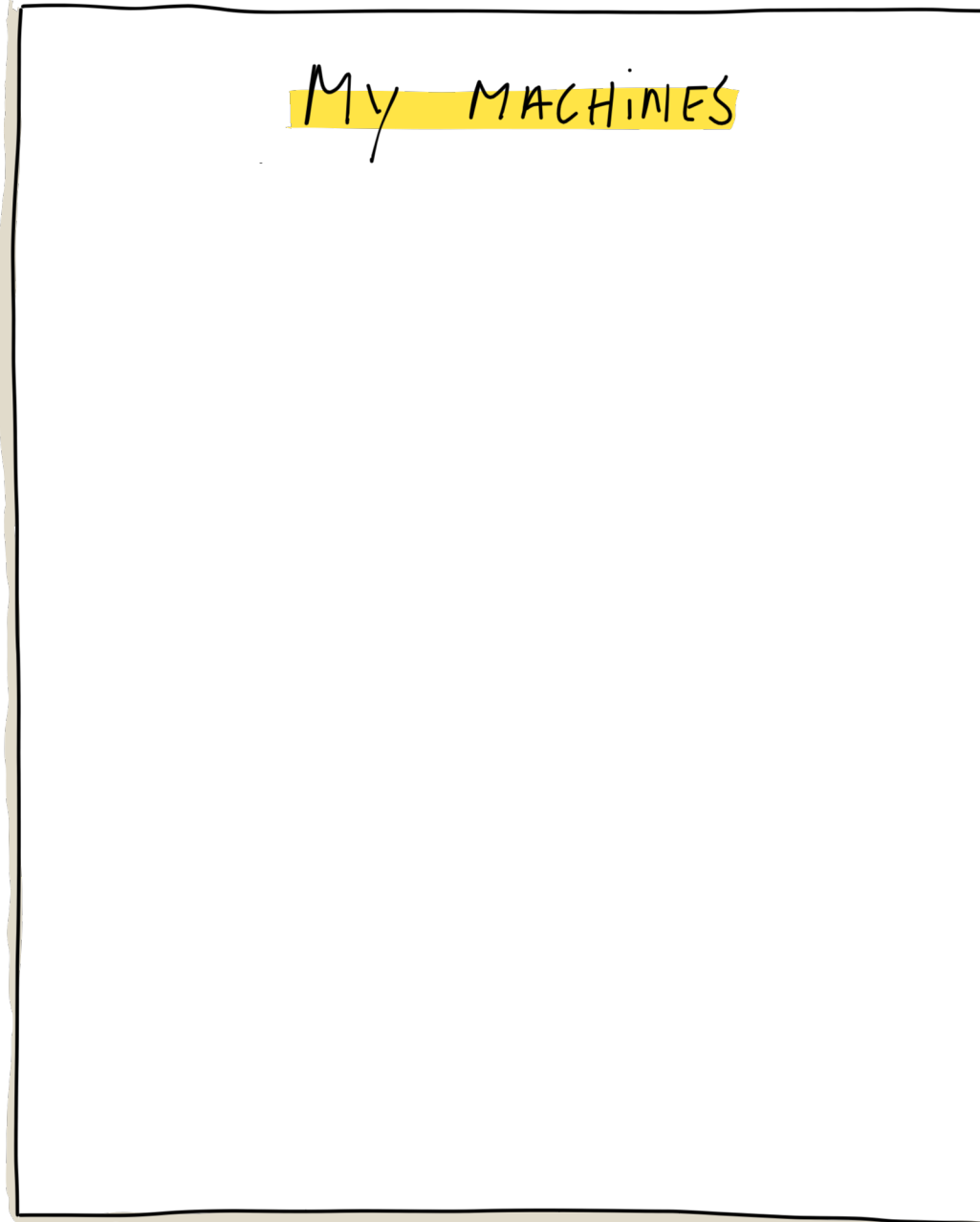
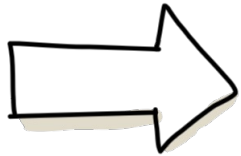
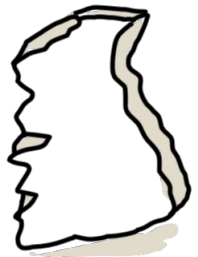

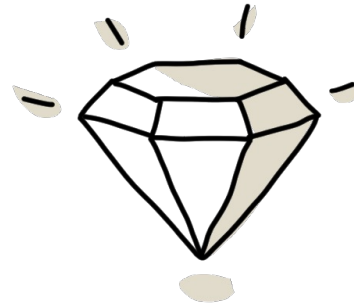
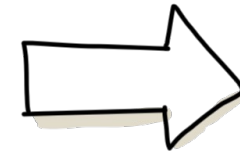
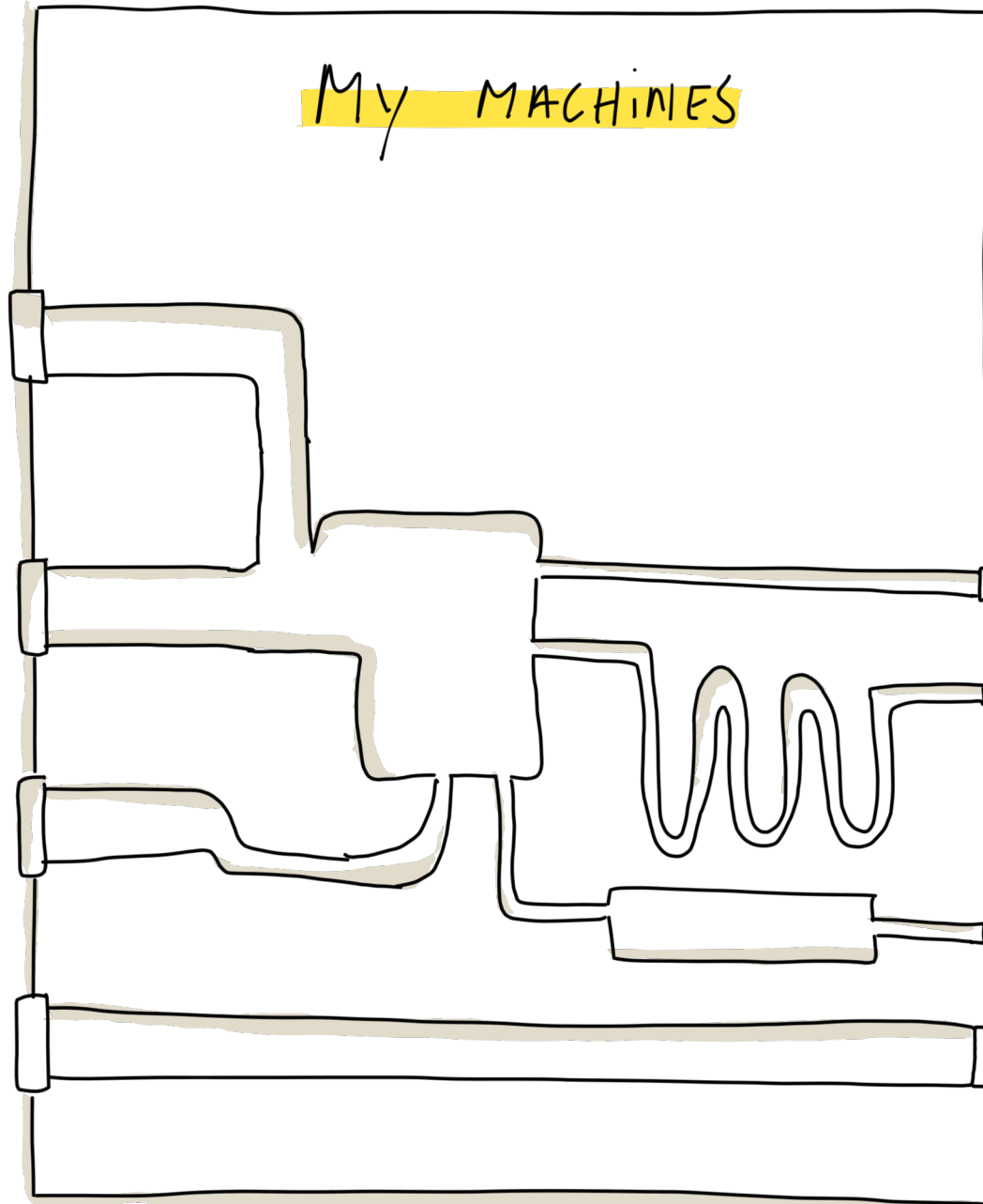
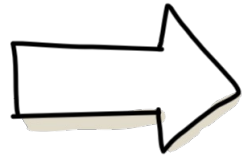
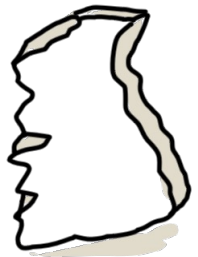

SOME INTROSPECTION...

# WERE THESE MACHINES A **SUCCESS**?



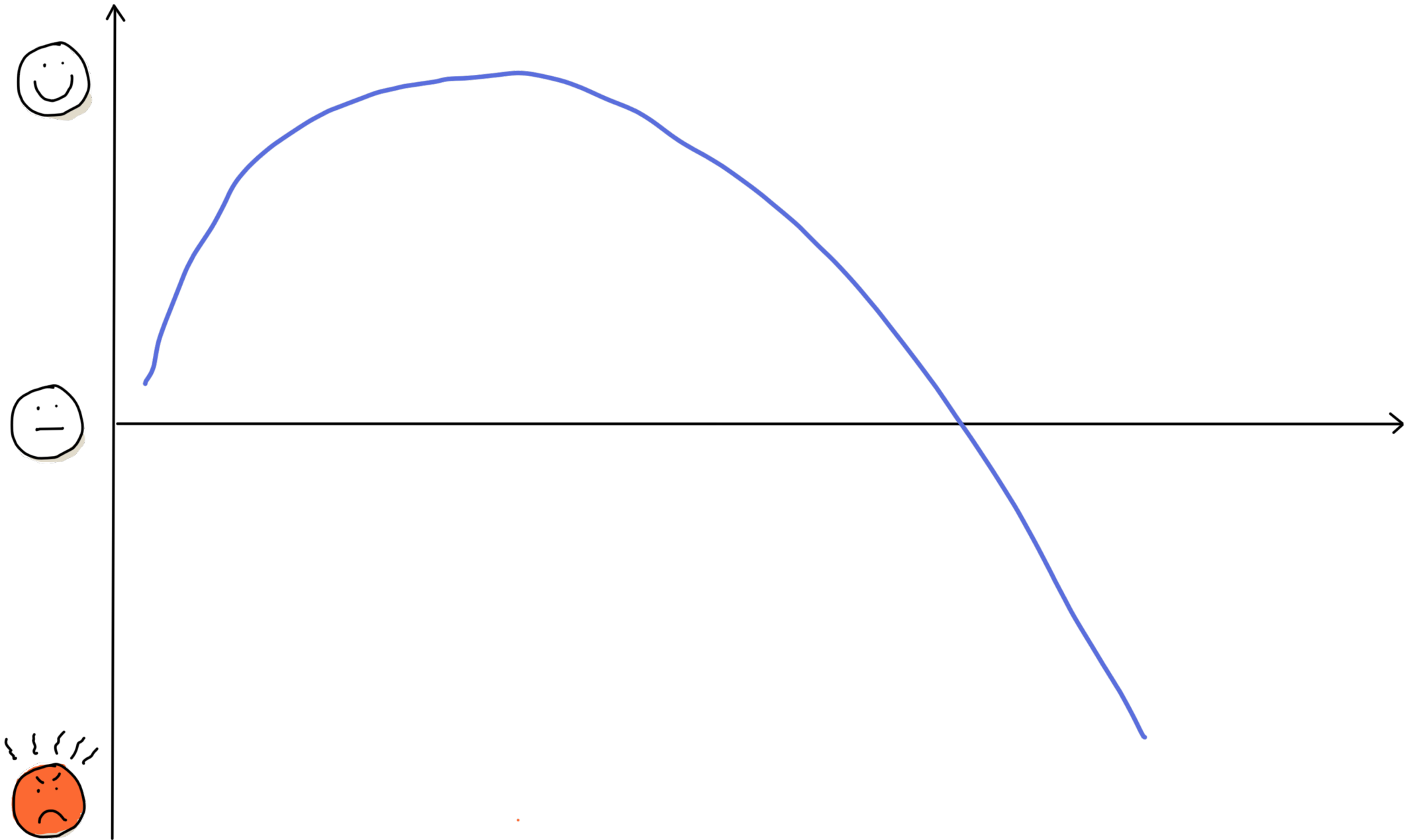

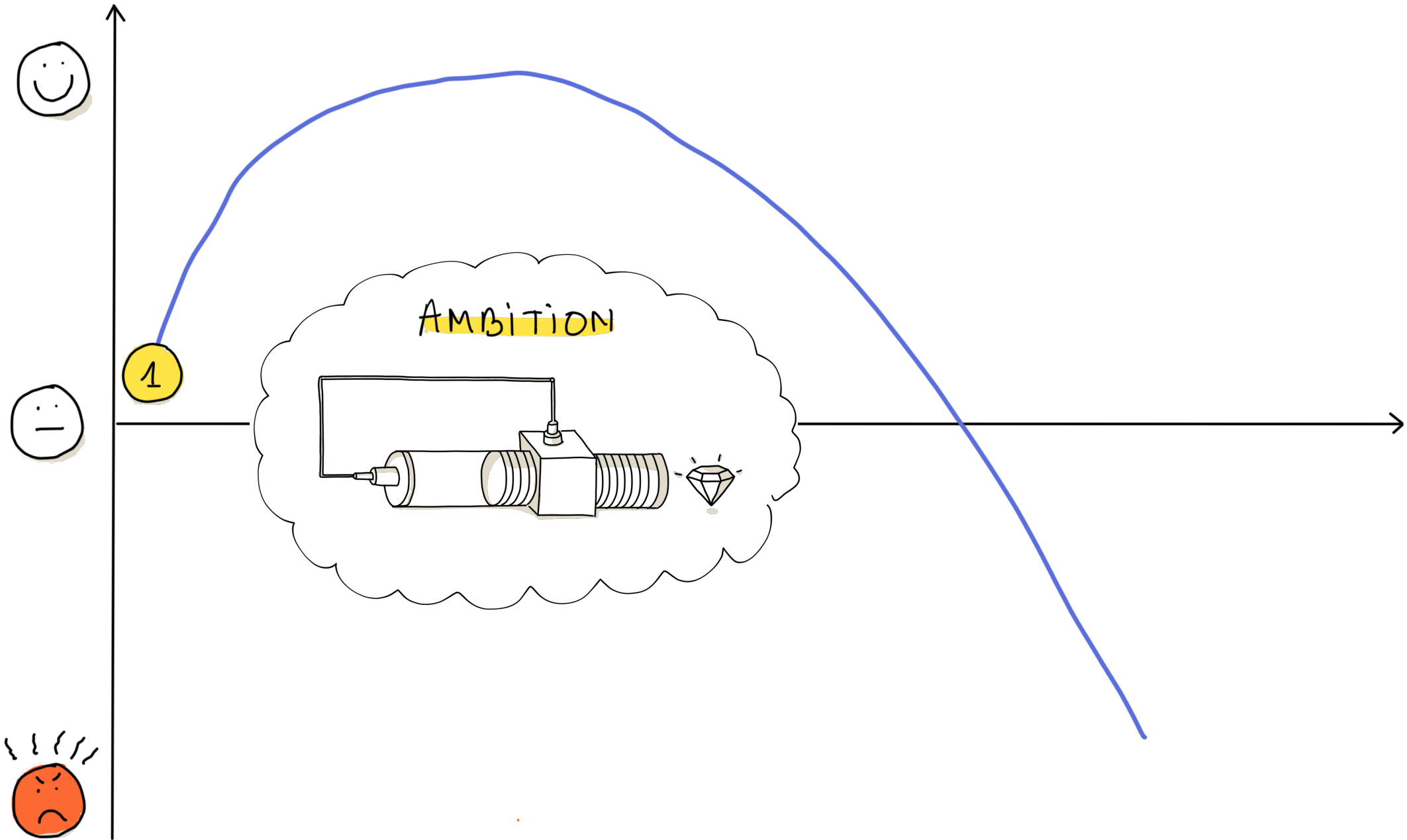

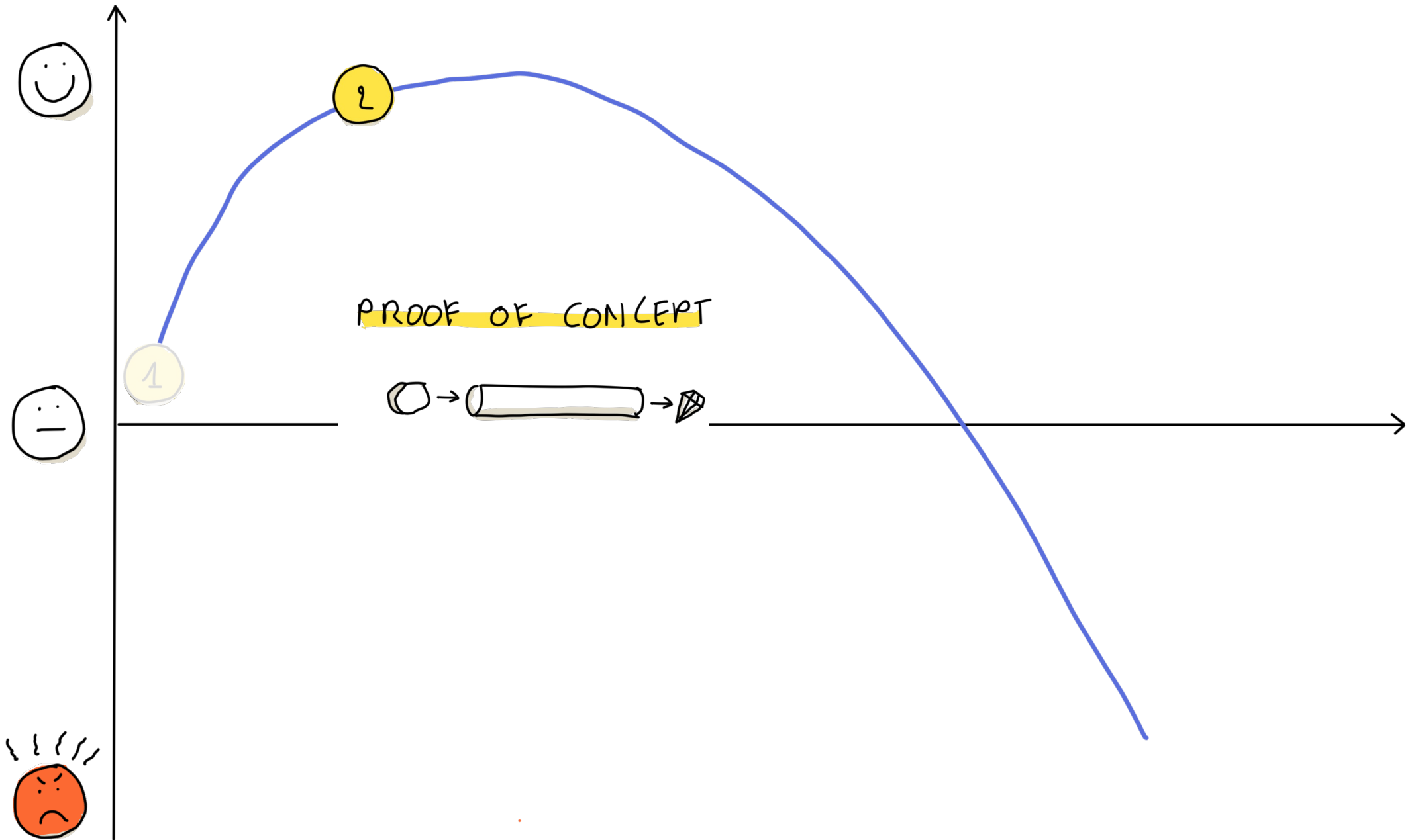

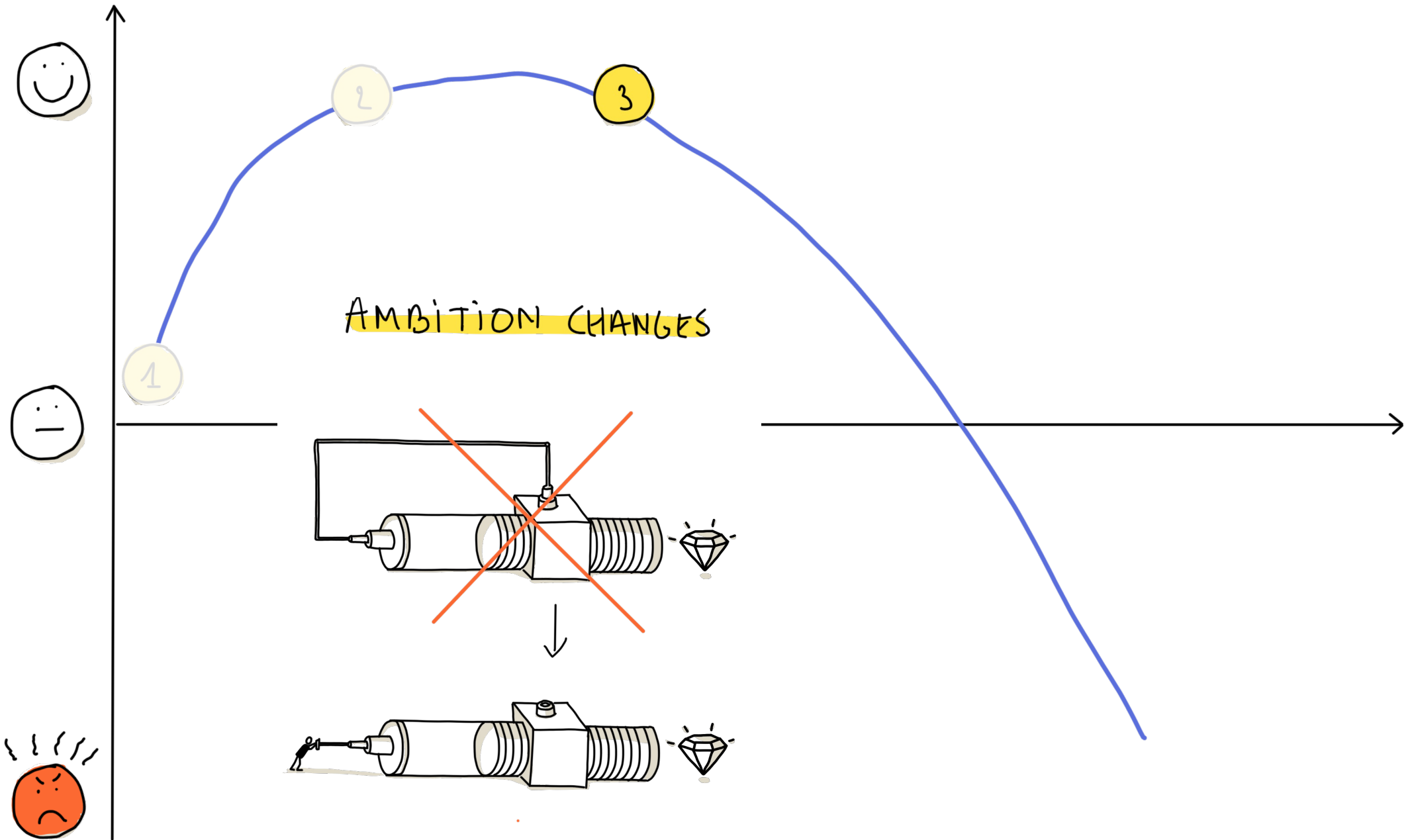

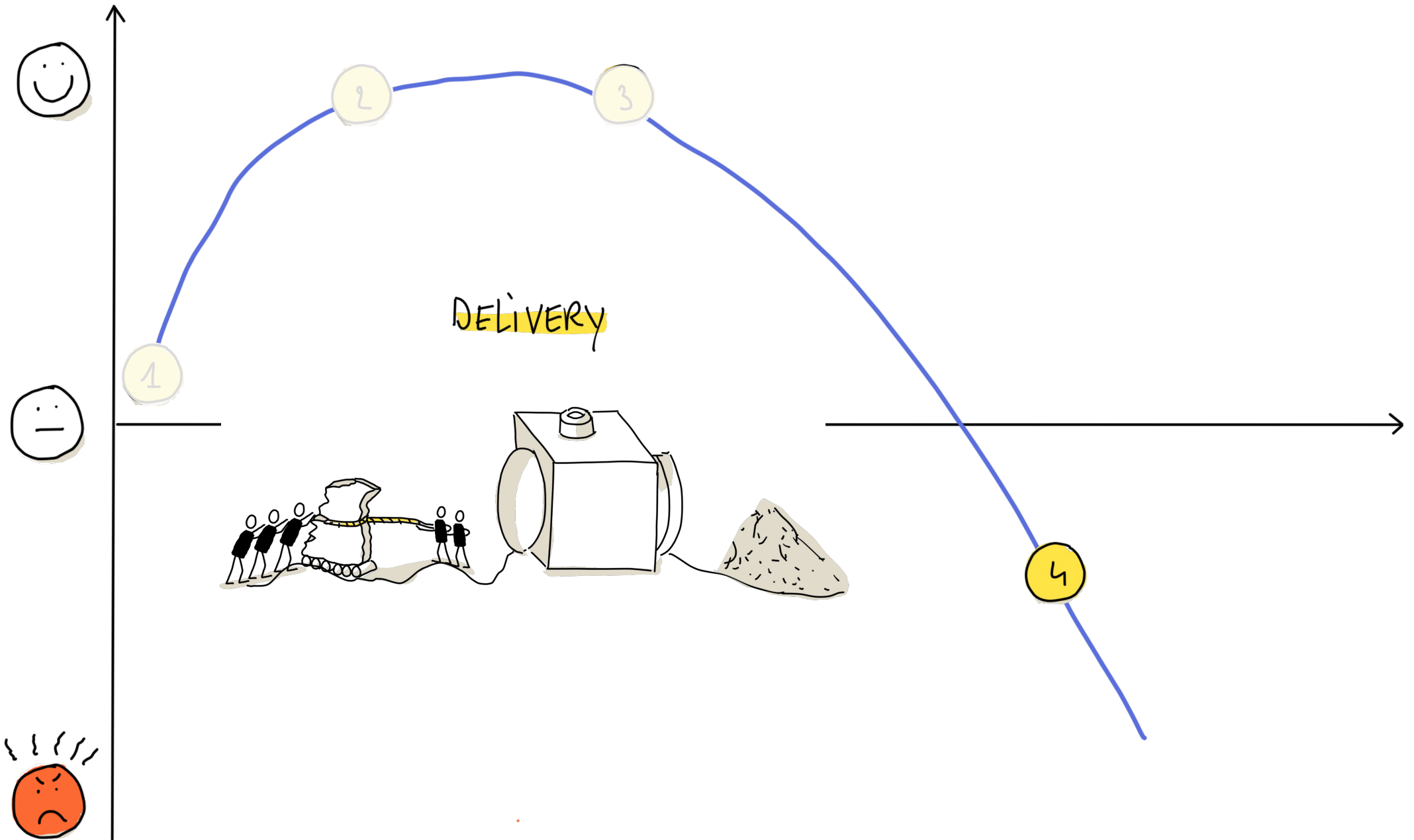



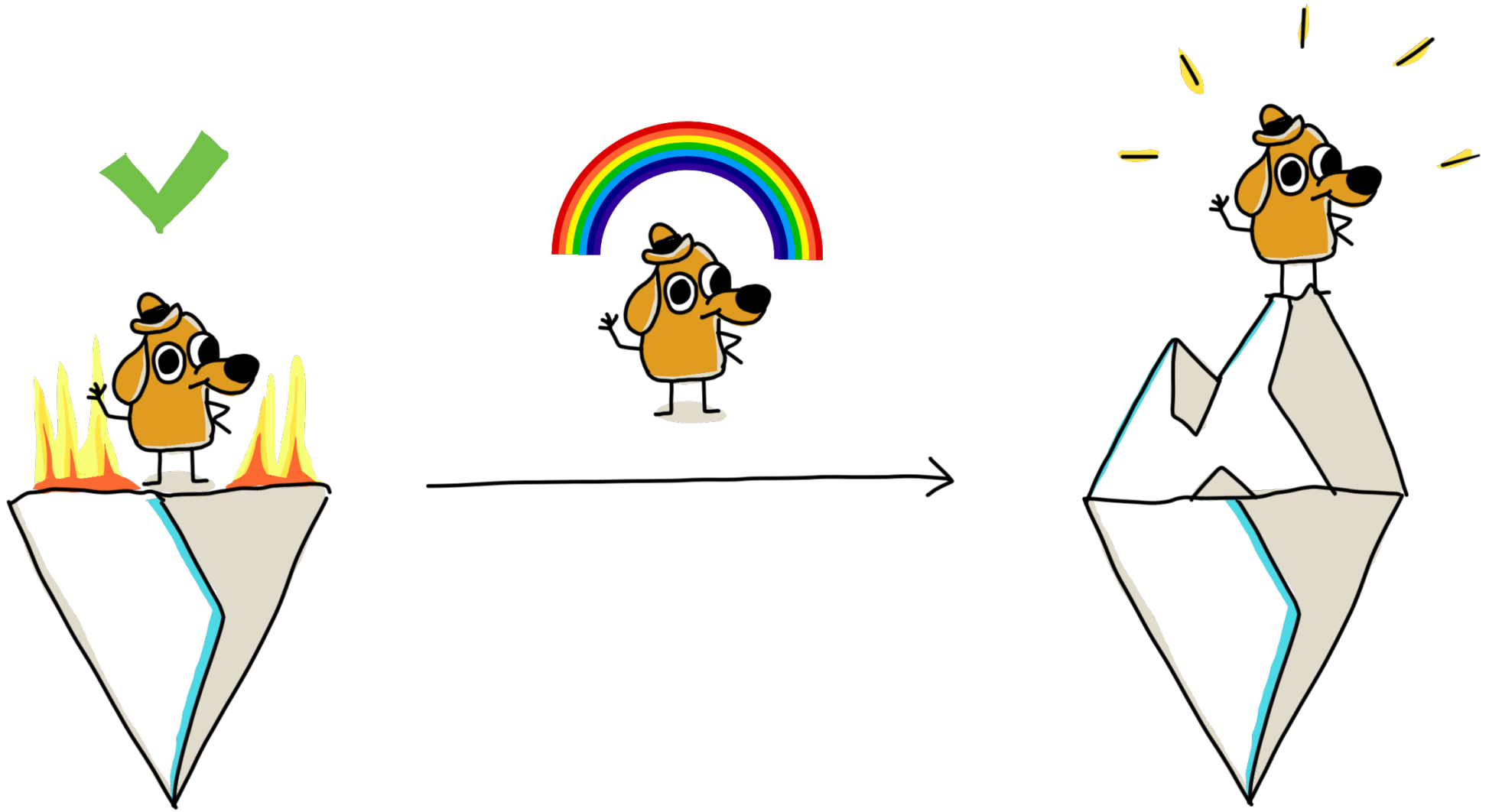

# MY JOURNEY TOWARDS VALUE FROM DATA

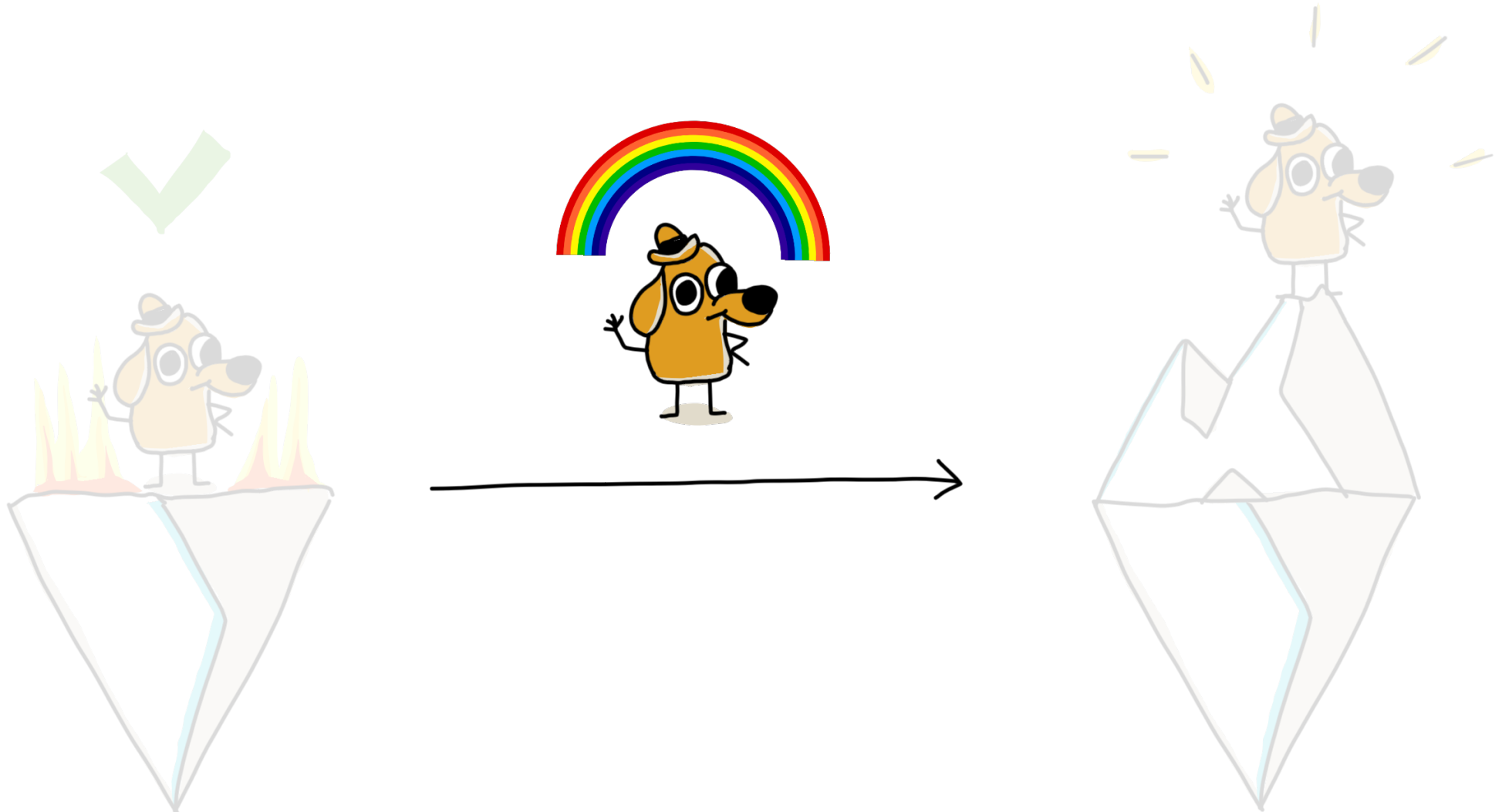

# MY JOURNEY TOWARDS VALUE FROM DATA

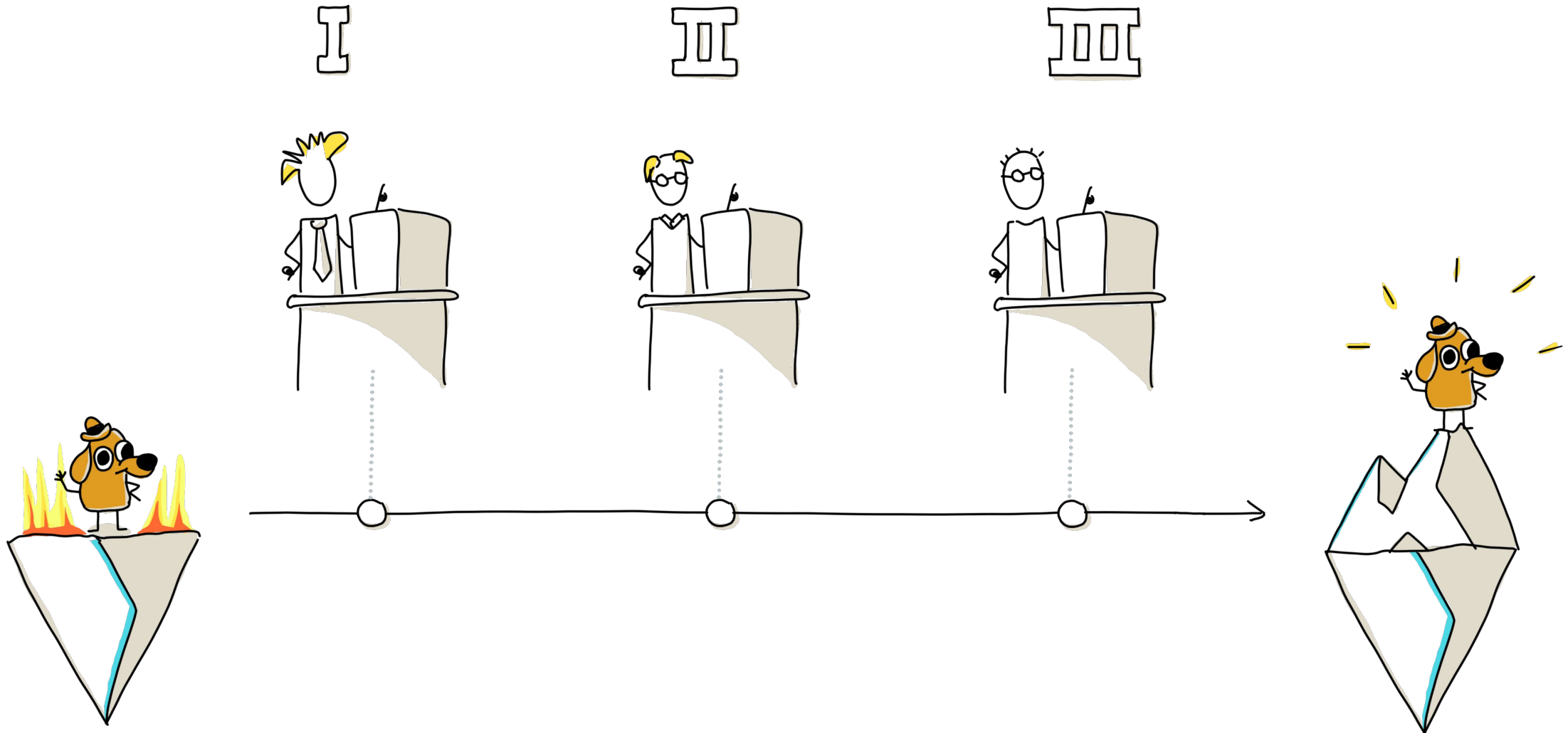

# THE DATA GOVERNANCE APPROACH

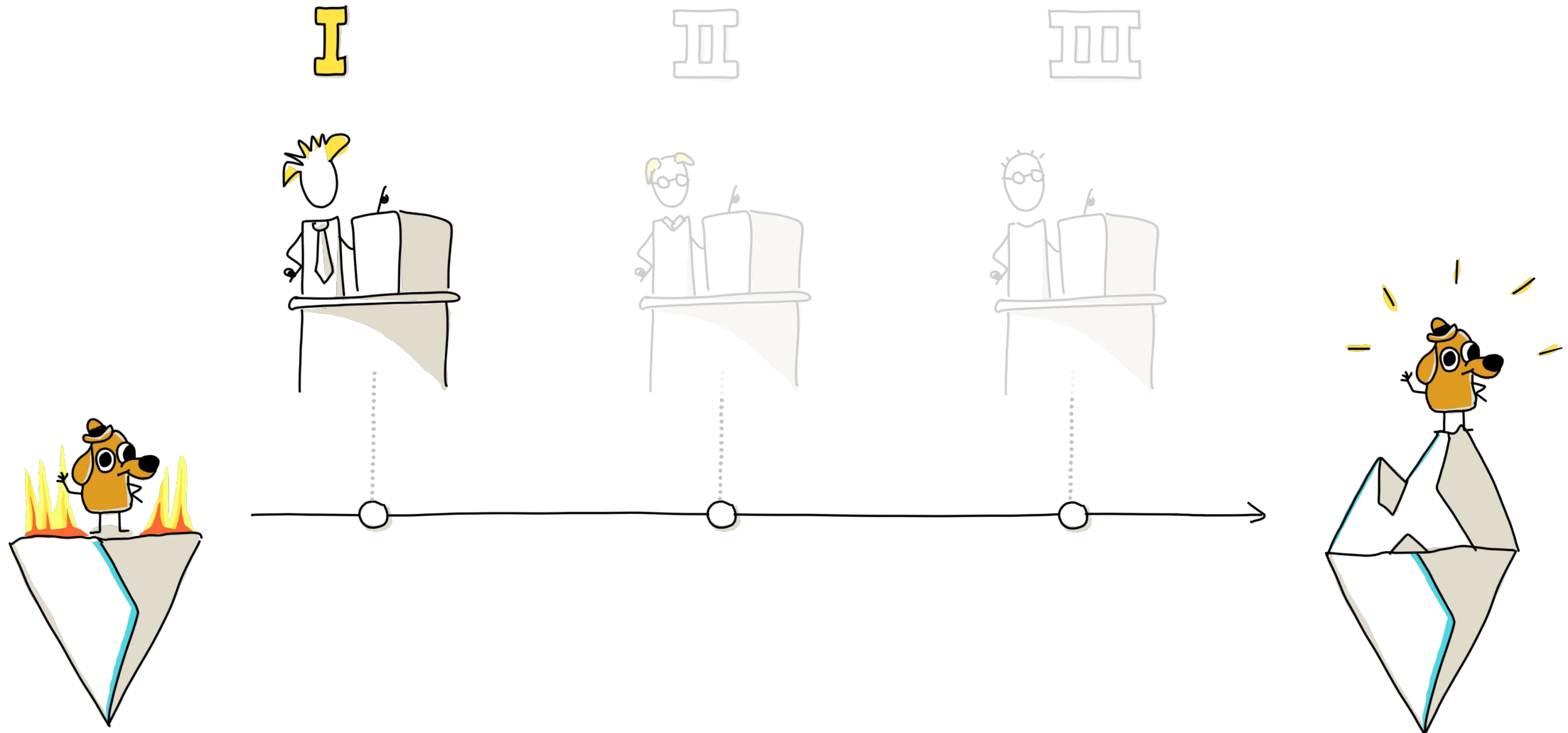



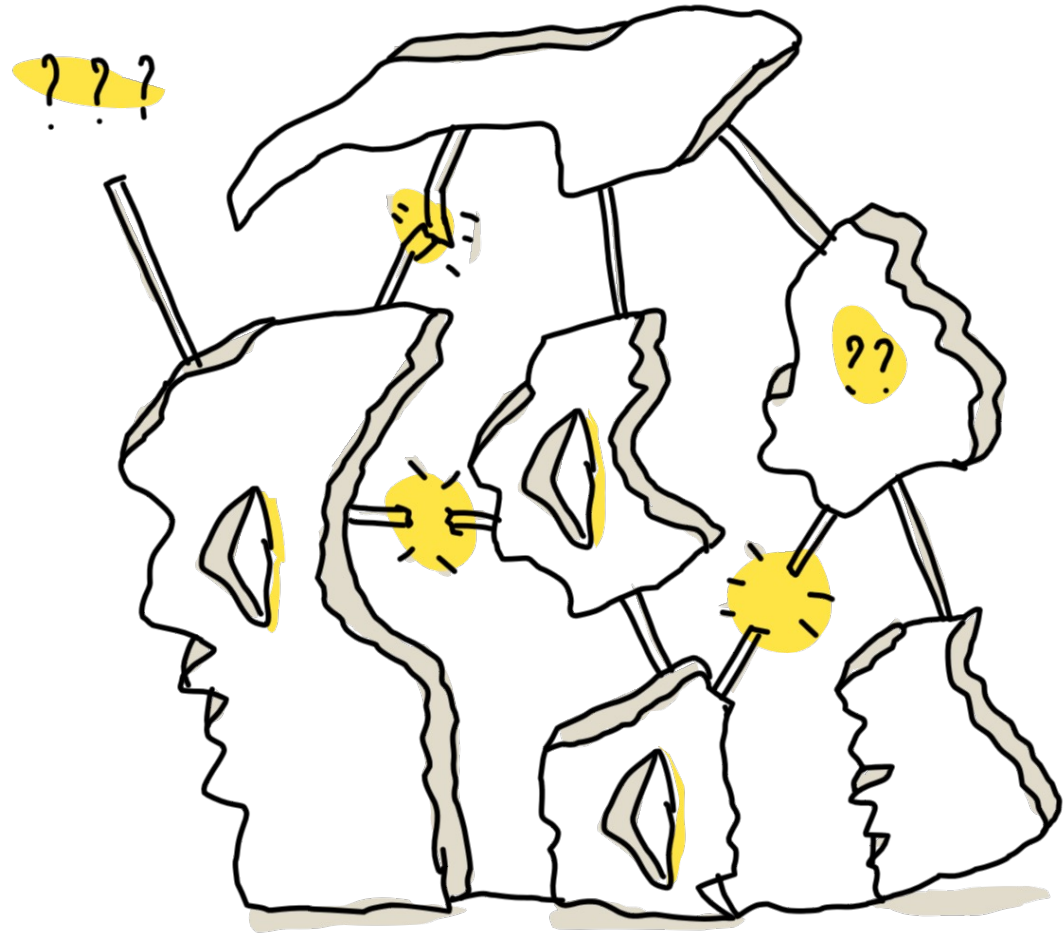

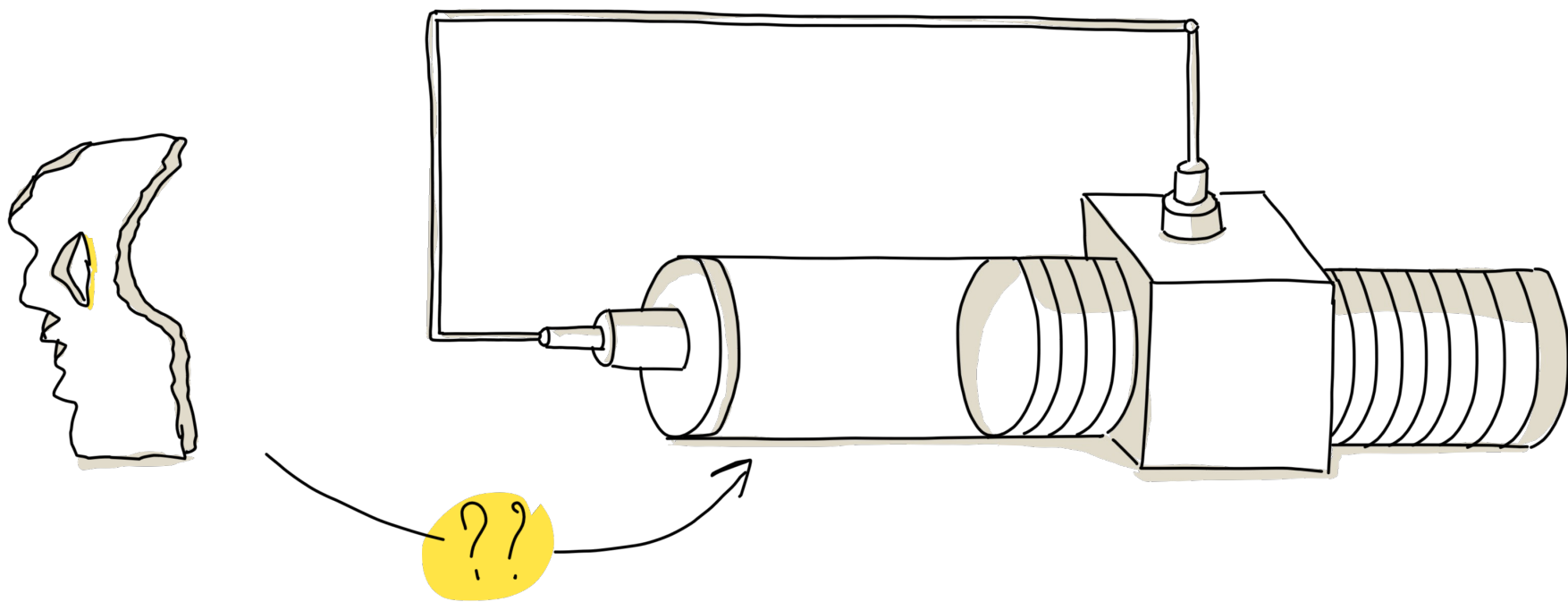

**DATA? WHICH DATA?**

**ENTER: DATA  
GOVERNANCE**

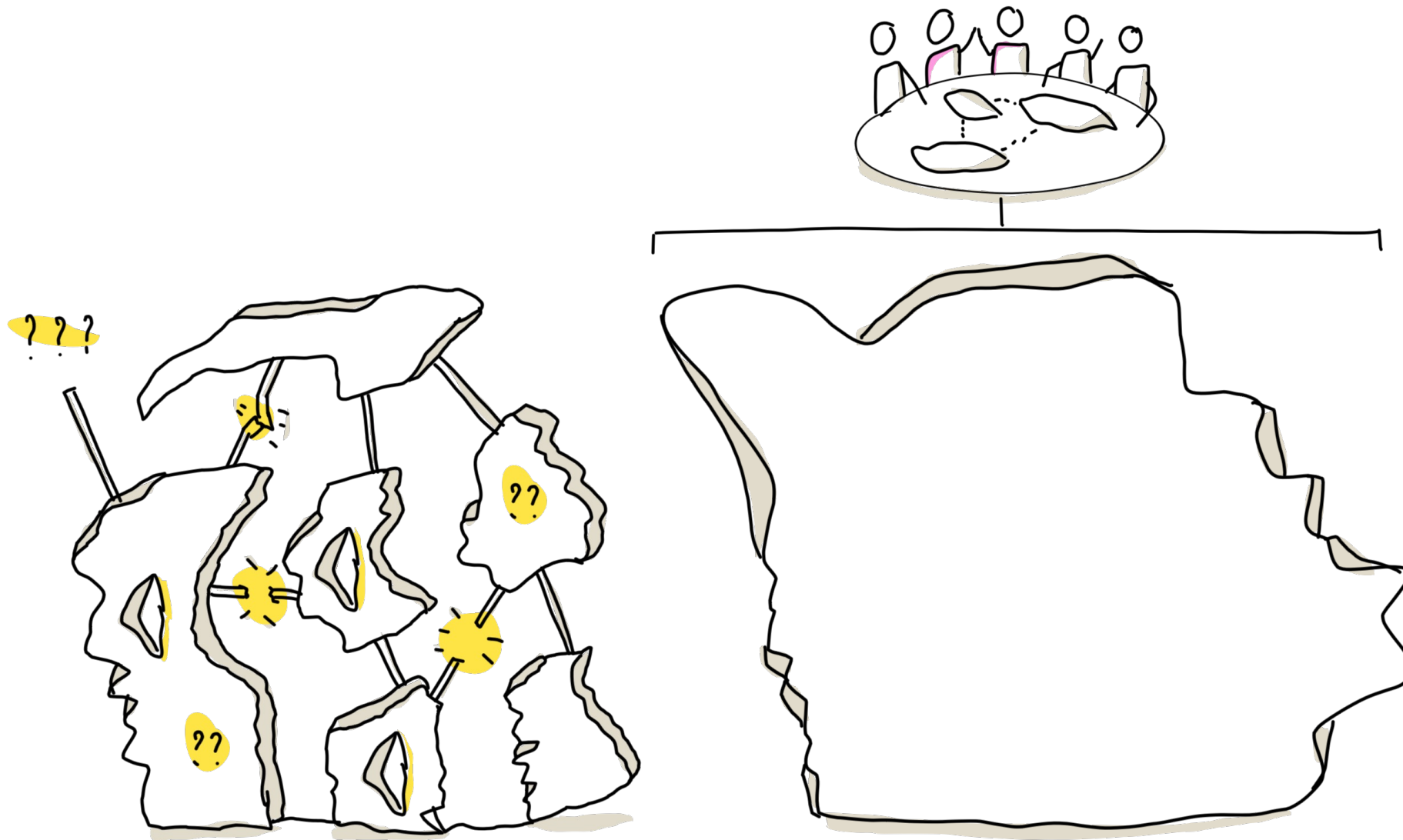

THE DATA

THE MODEL

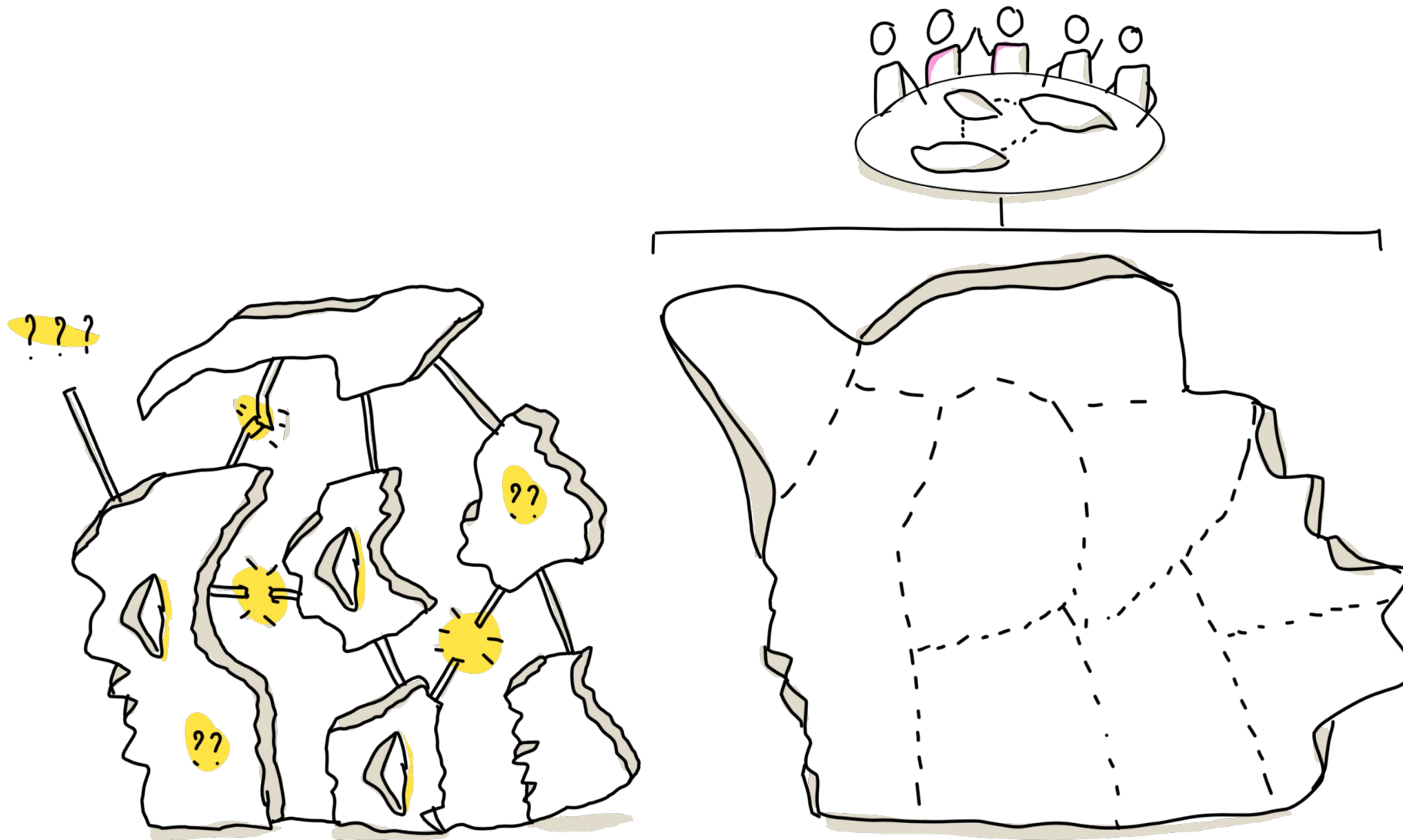

THE DATA

THE MODEL

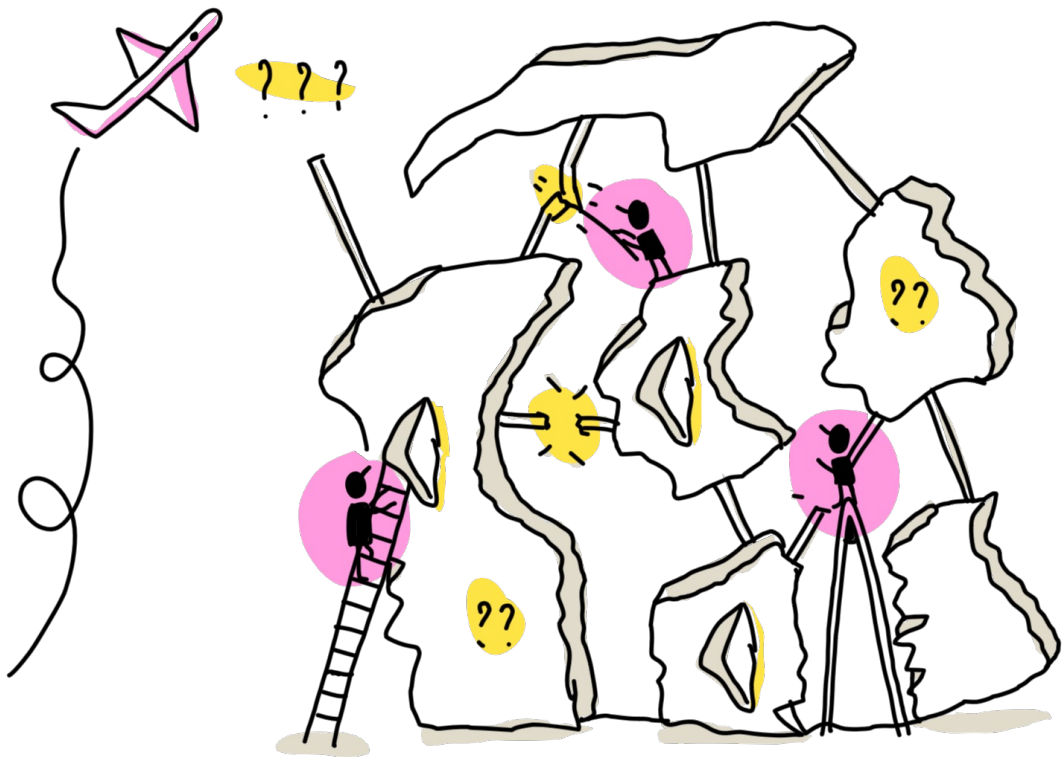

THE ENHANCED DATA

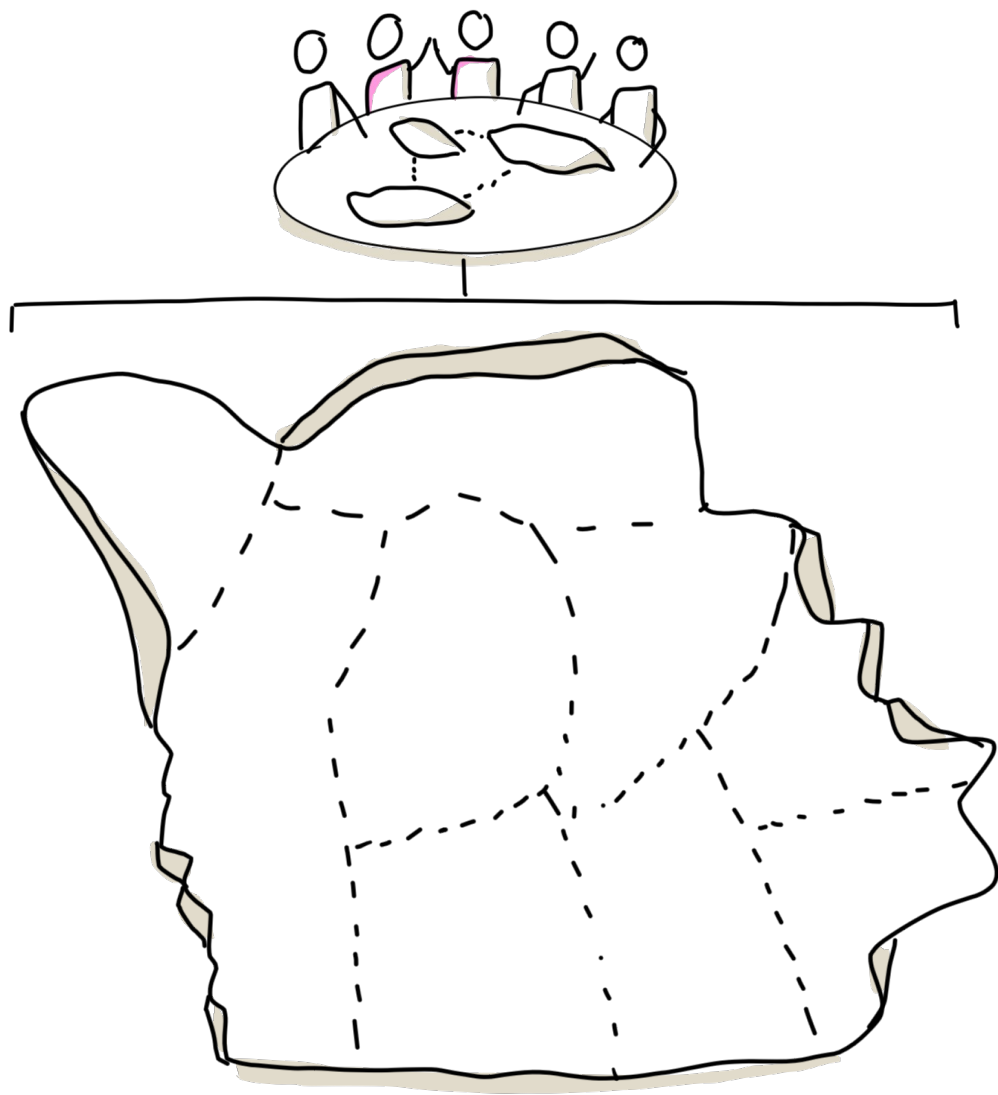

THE MODEL

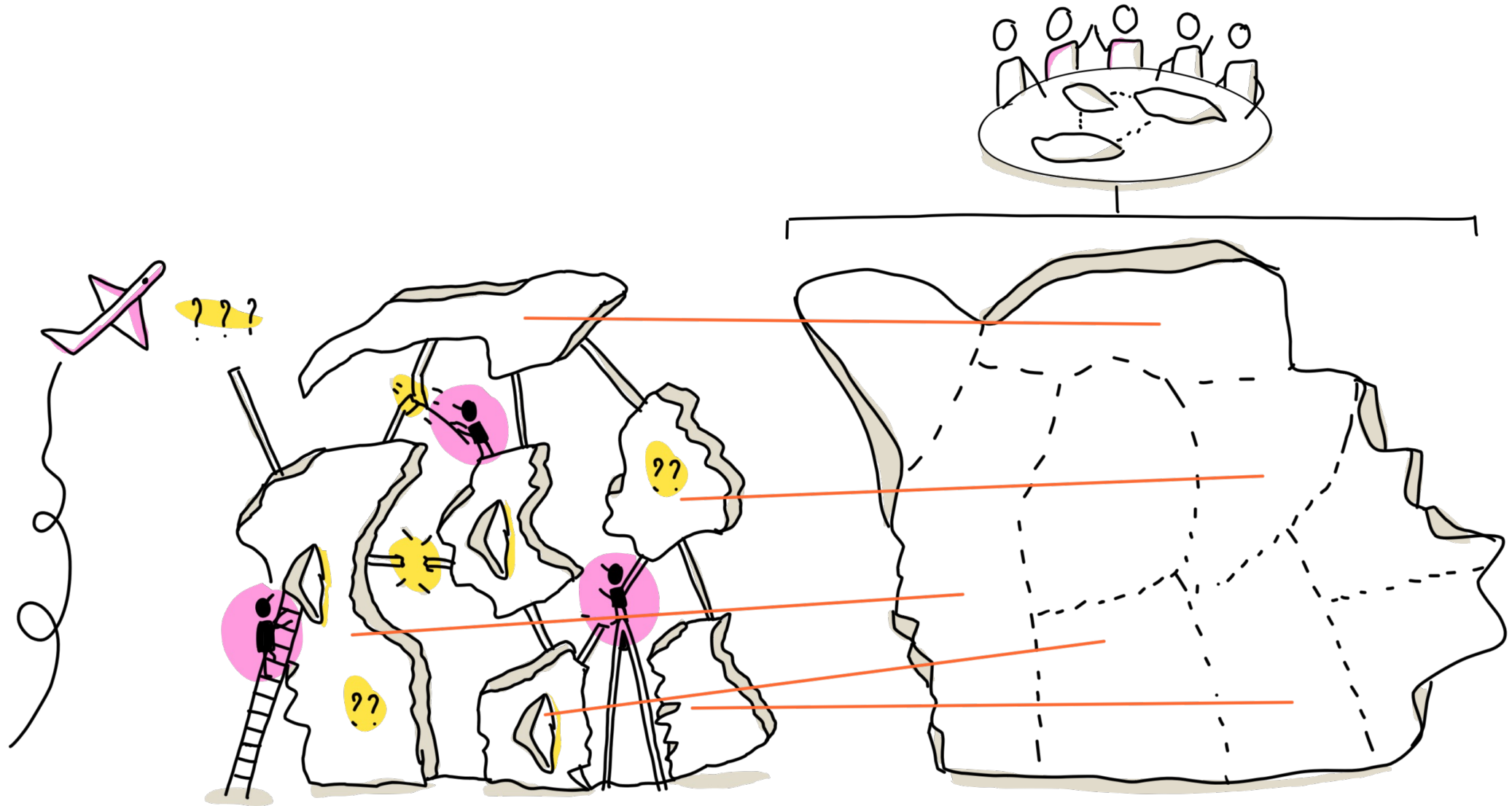

THE ENHANCED DATA

THE MODEL

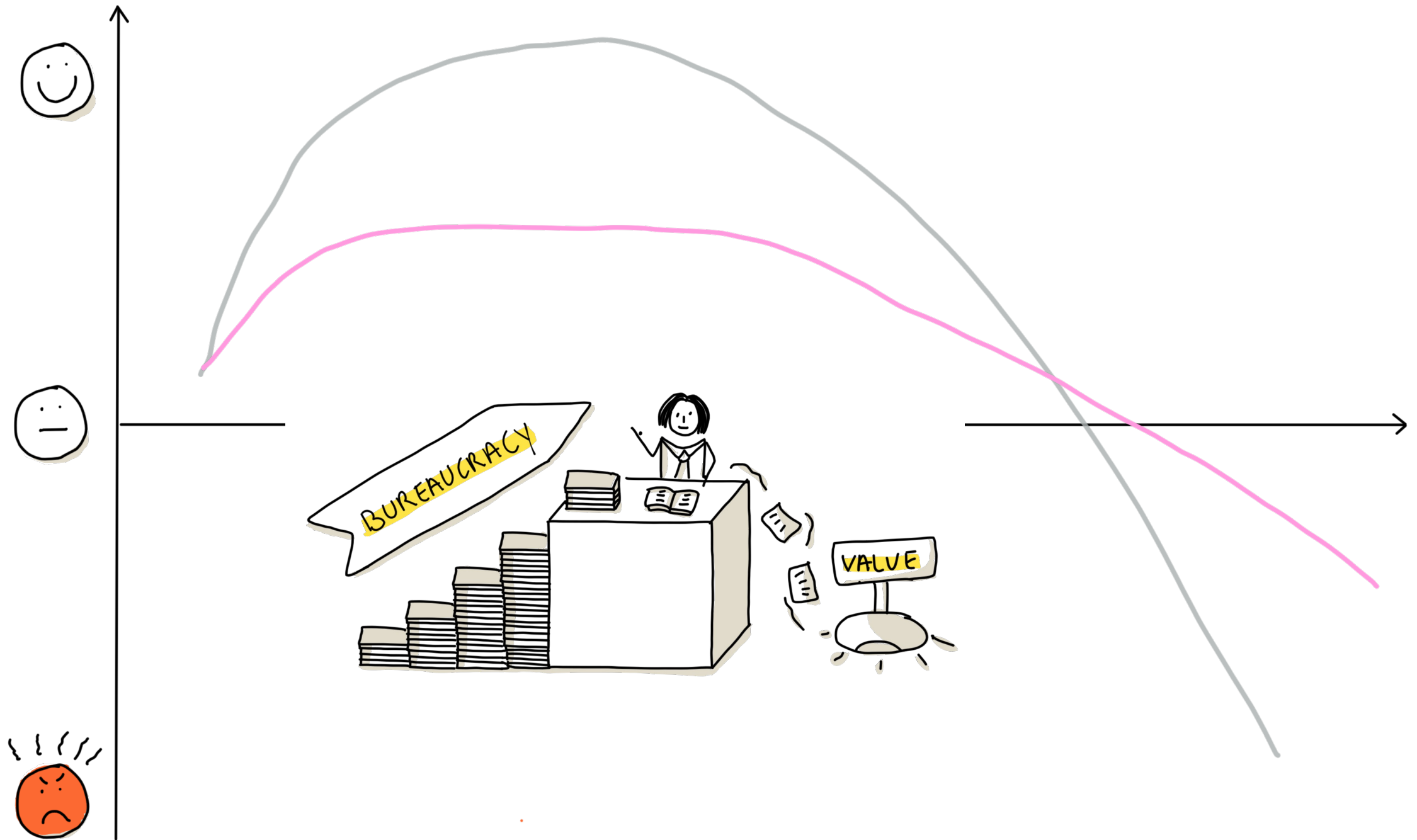

# MY JOURNEY TOWARDS VALUE FROM DATA

I ✓

II

III

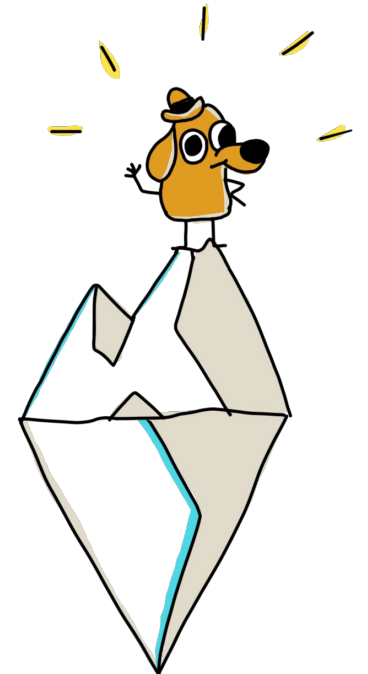
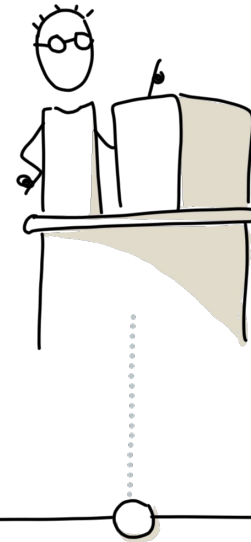
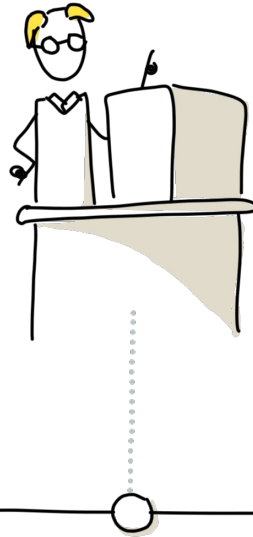

# THE DATA PRODUCT APPROACH

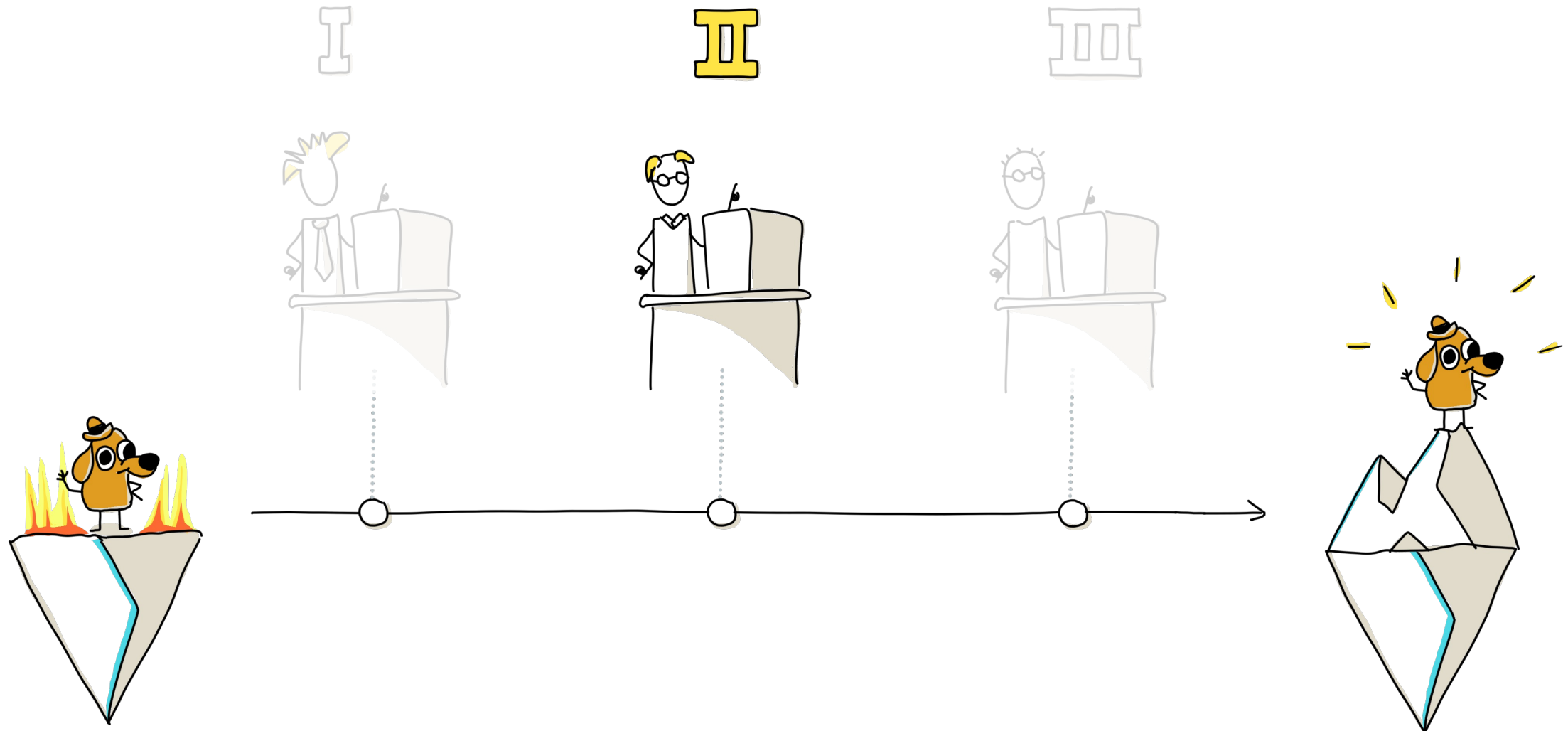

## How to Eat an Elephant?

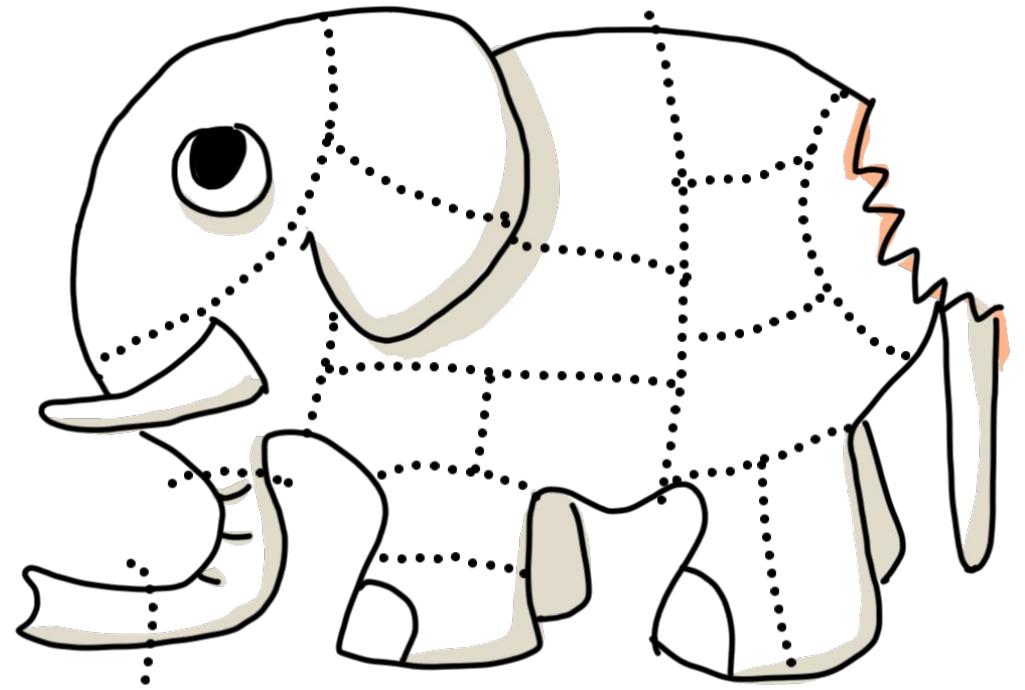
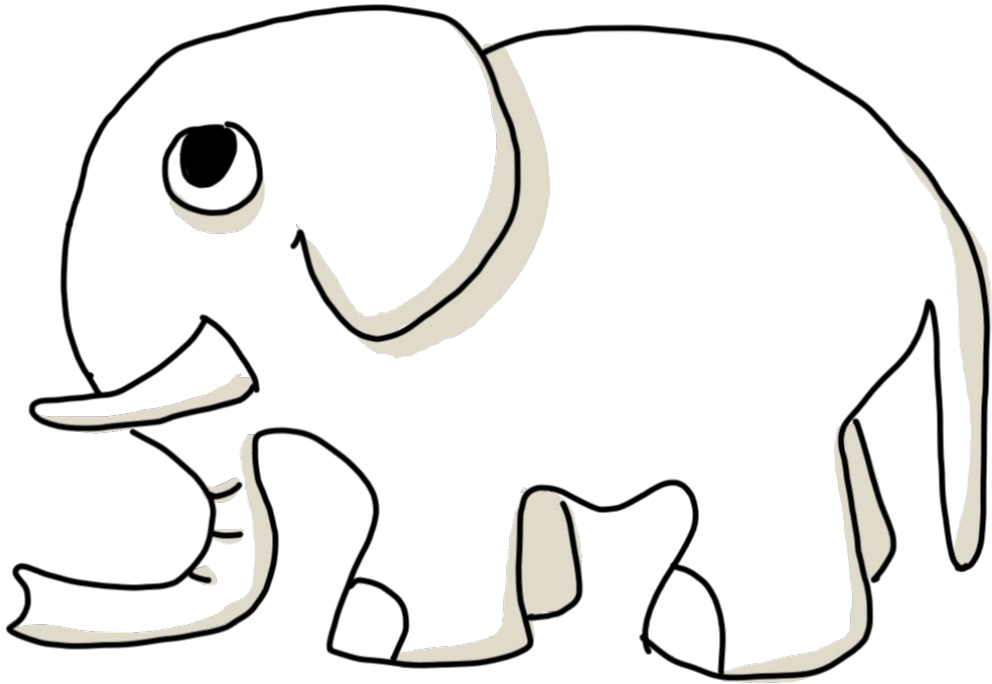

**One bite at a time**

## How to start a **Data Governance Program?**

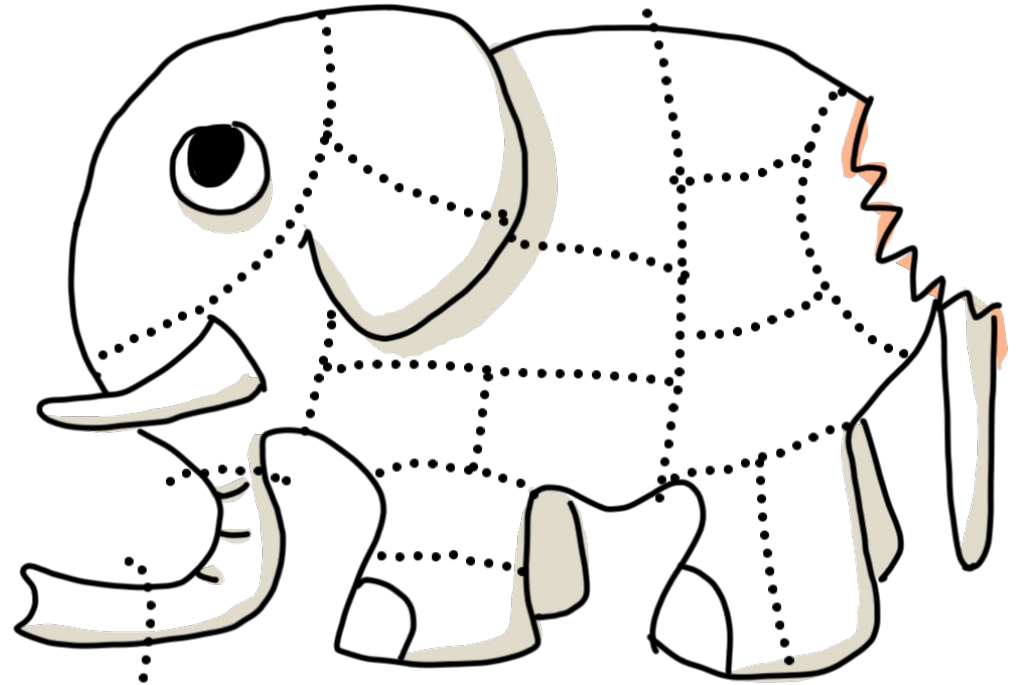
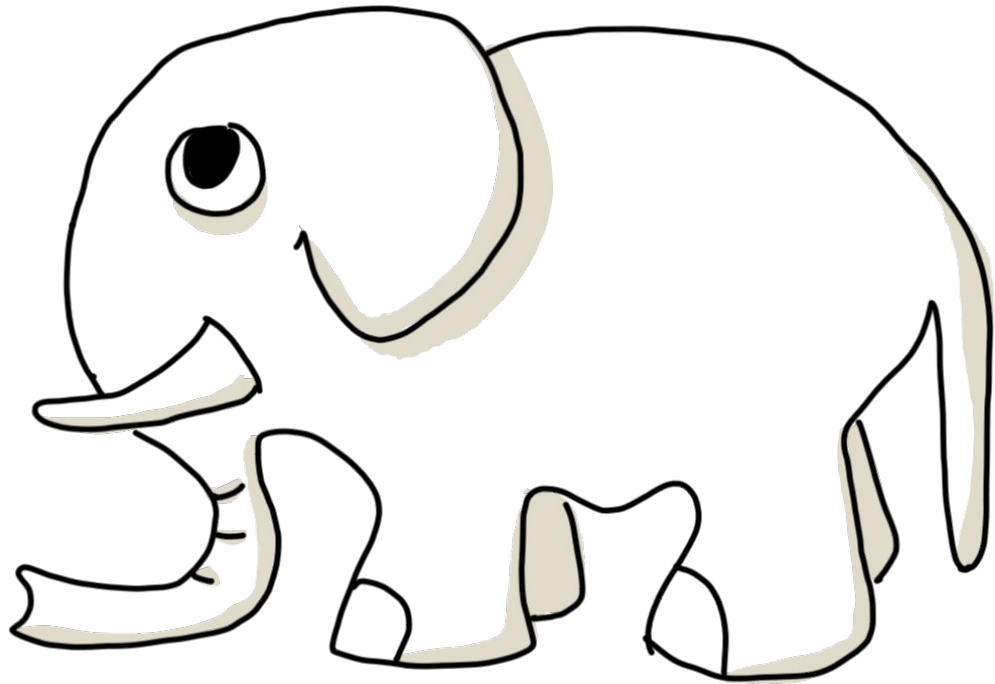

**Piece by Piece**

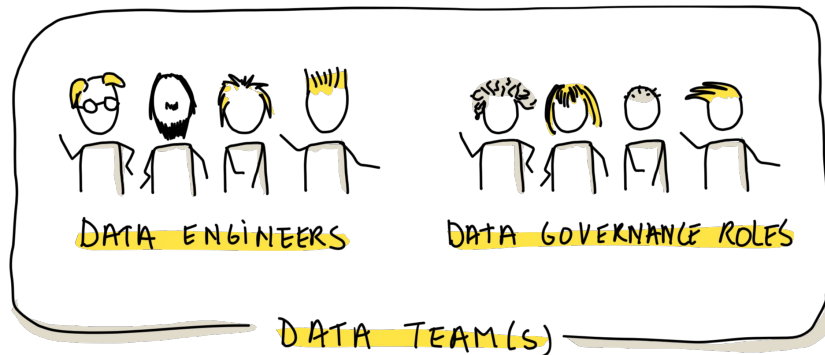
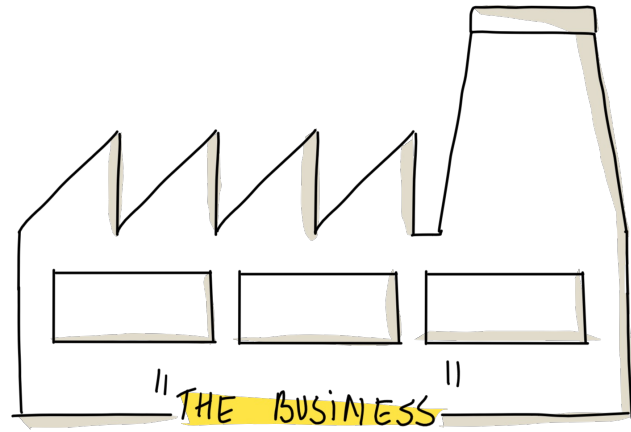

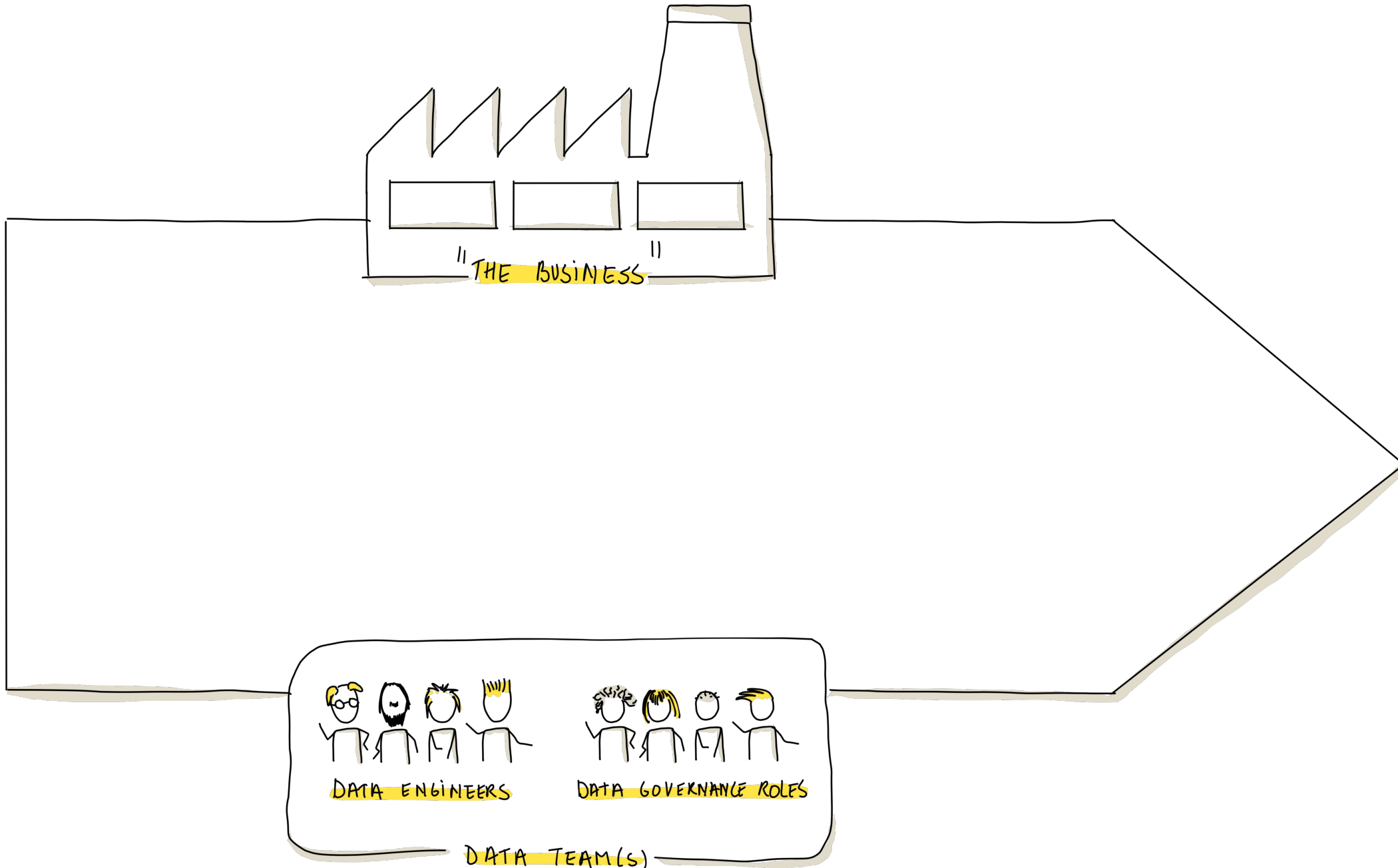

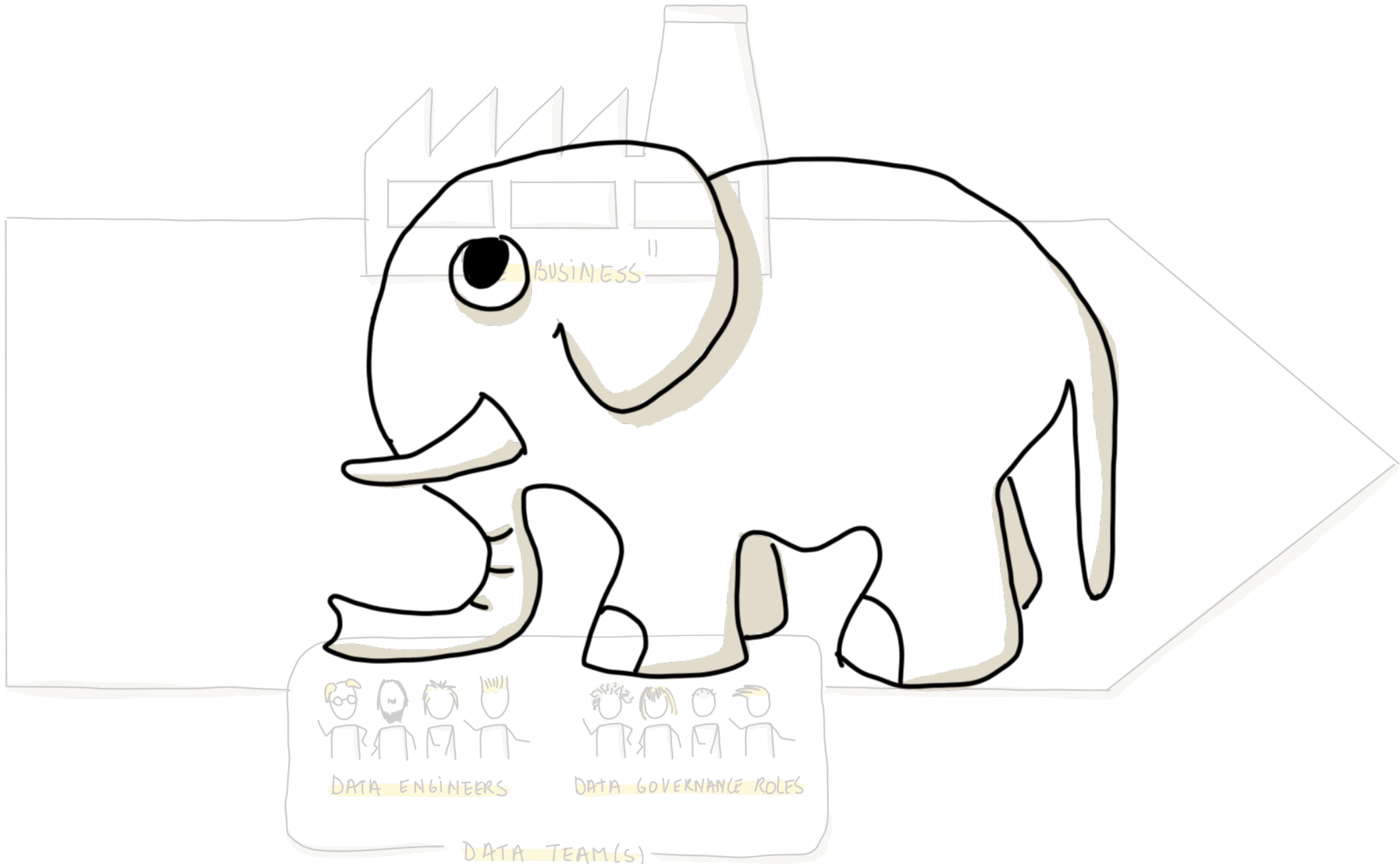

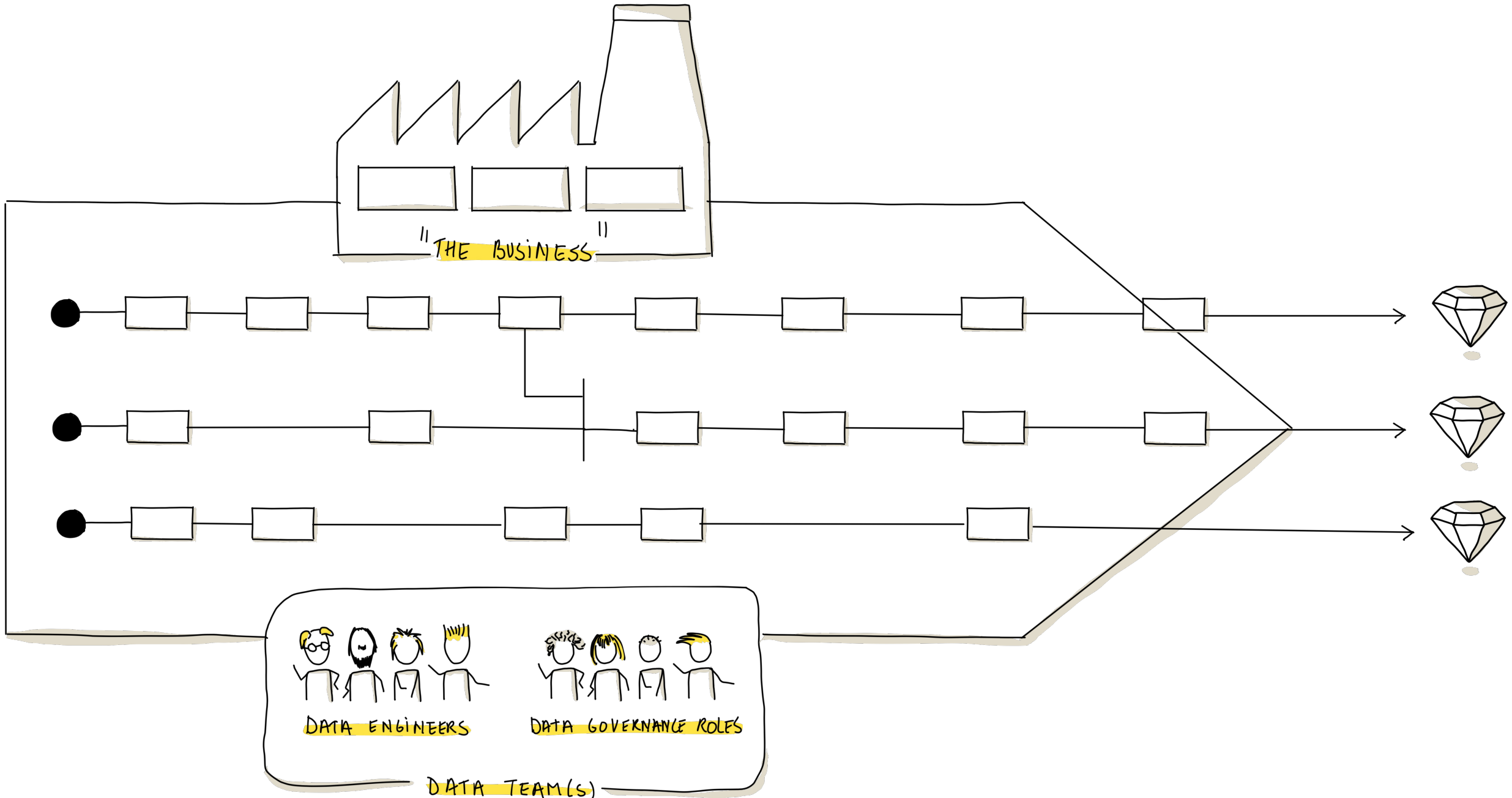

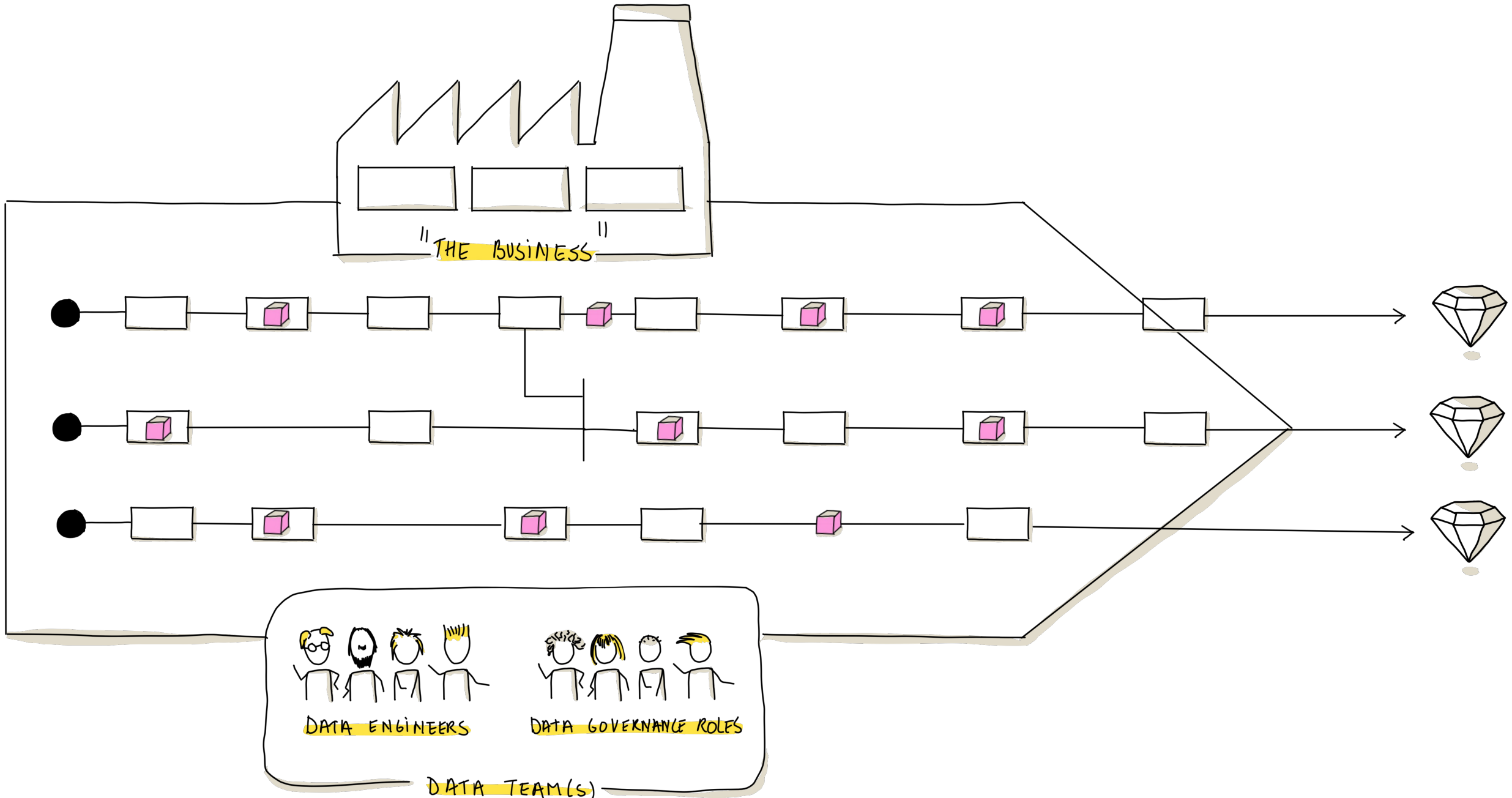

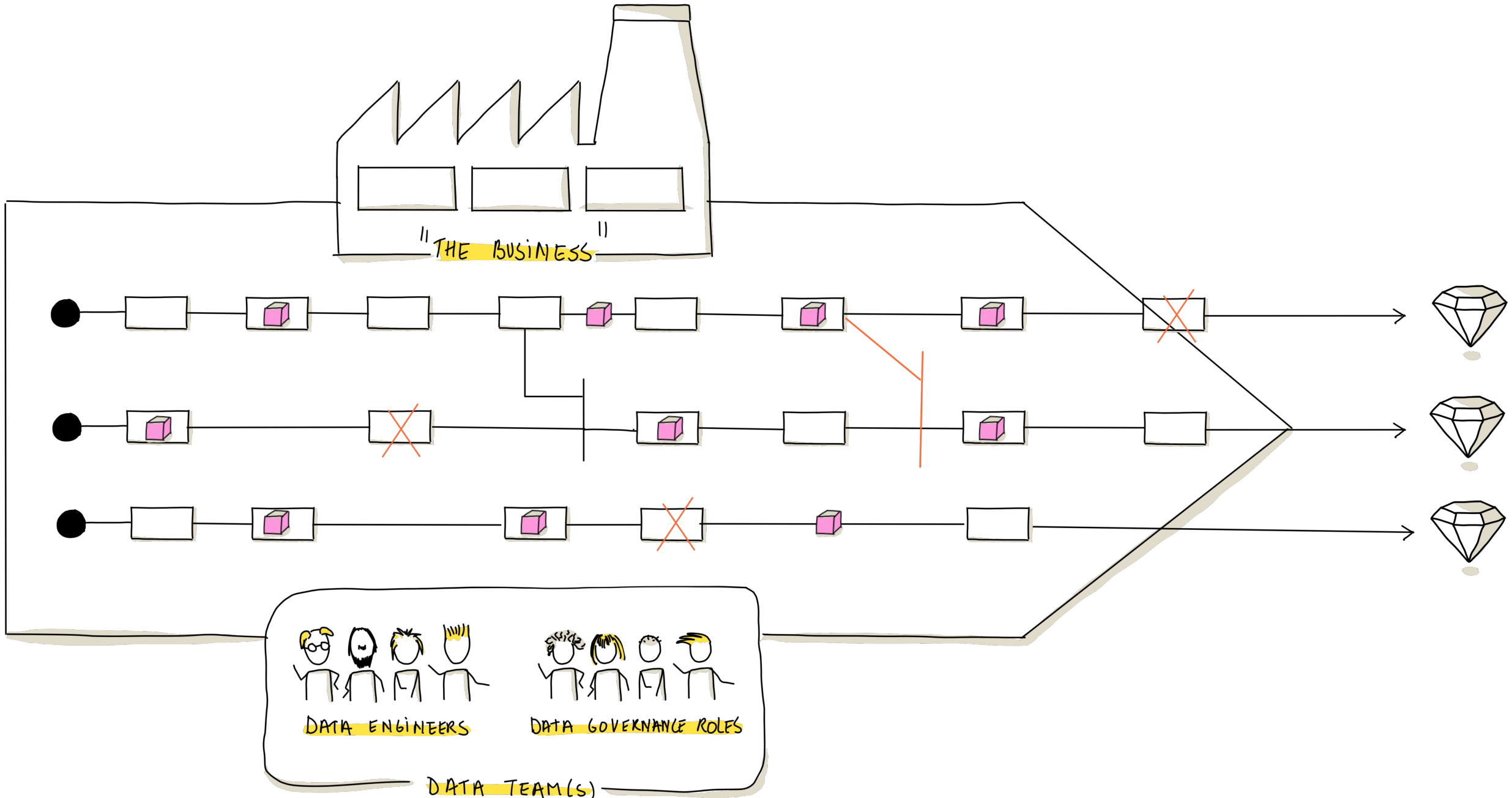

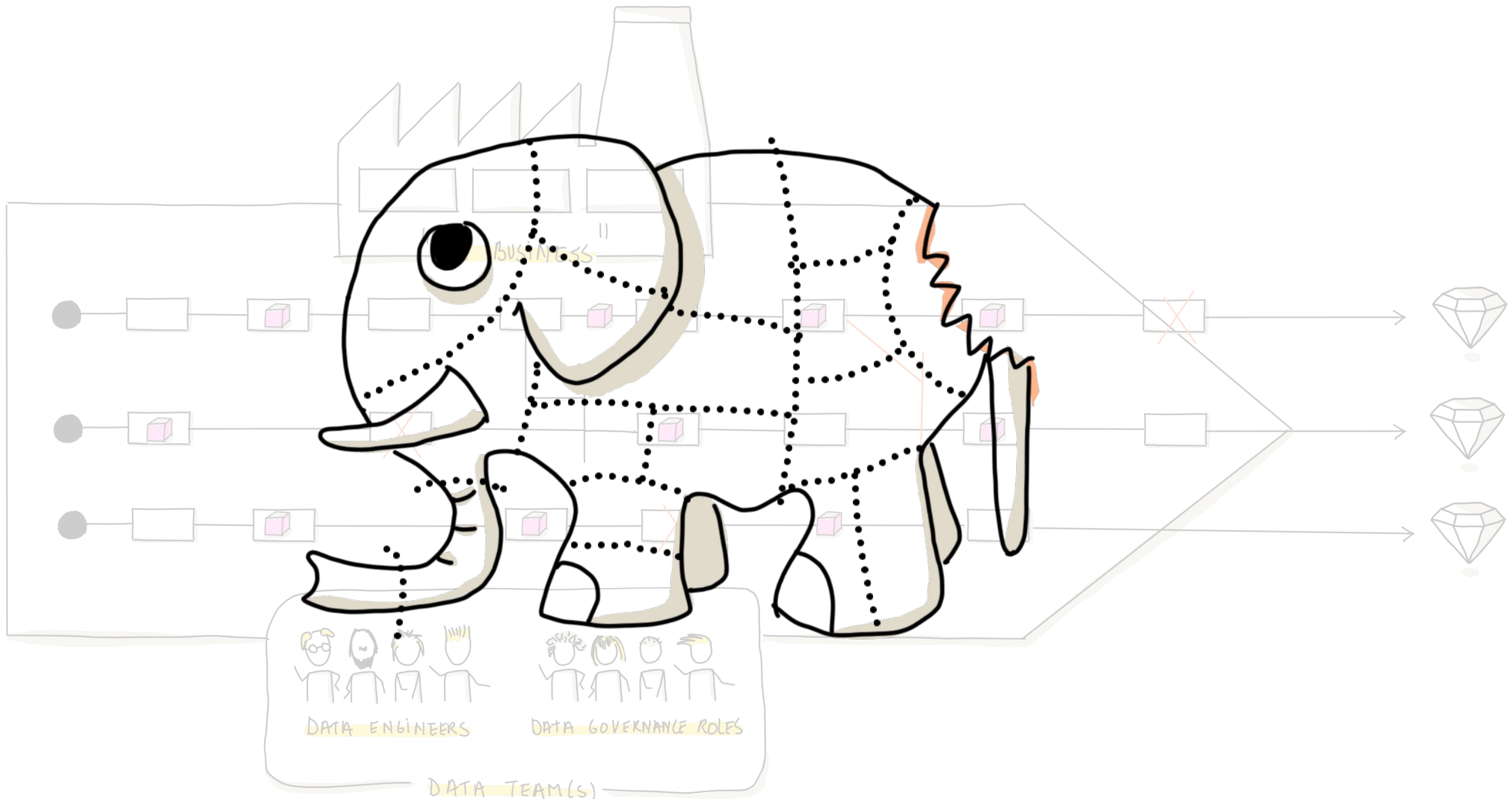

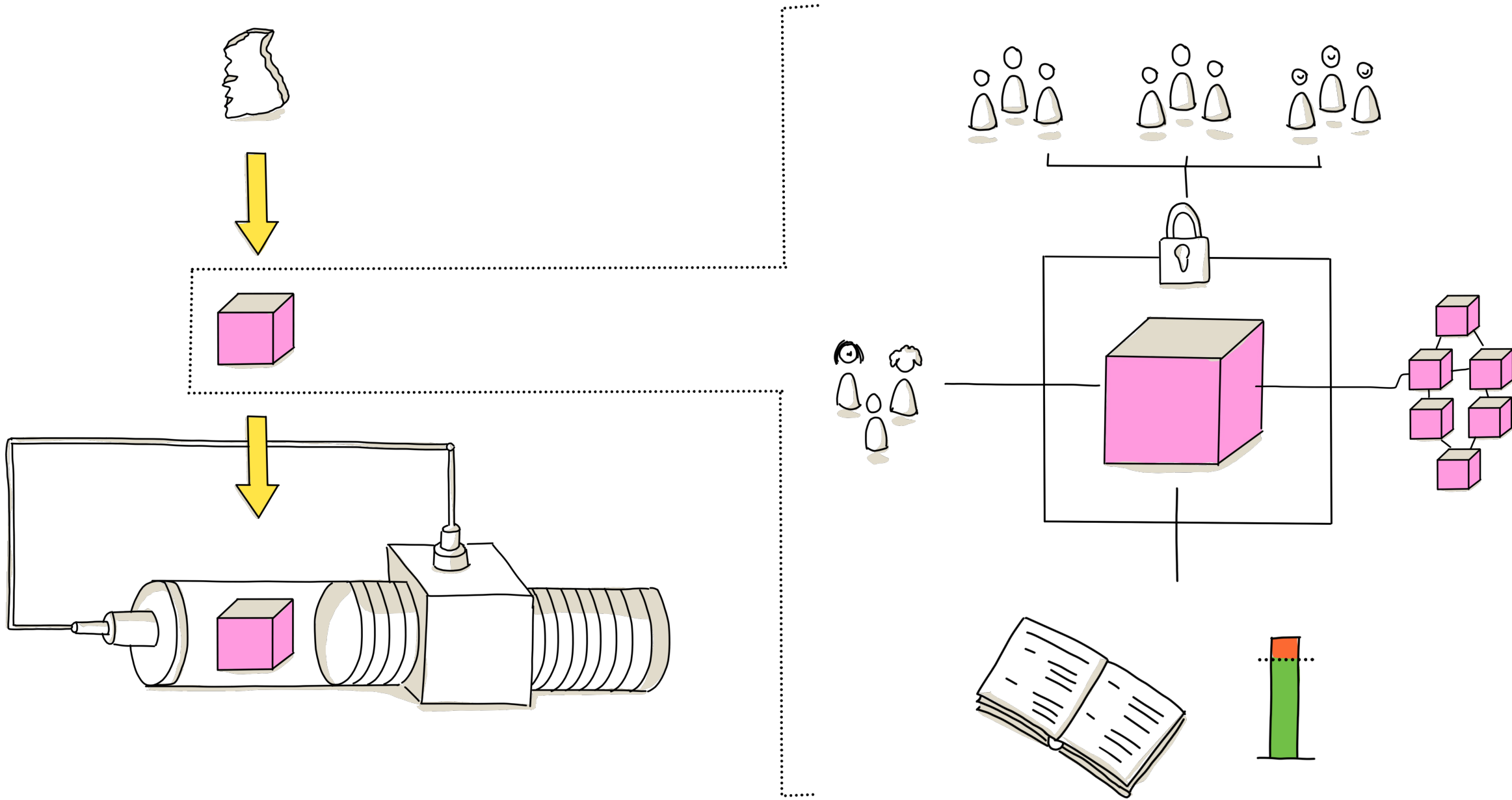

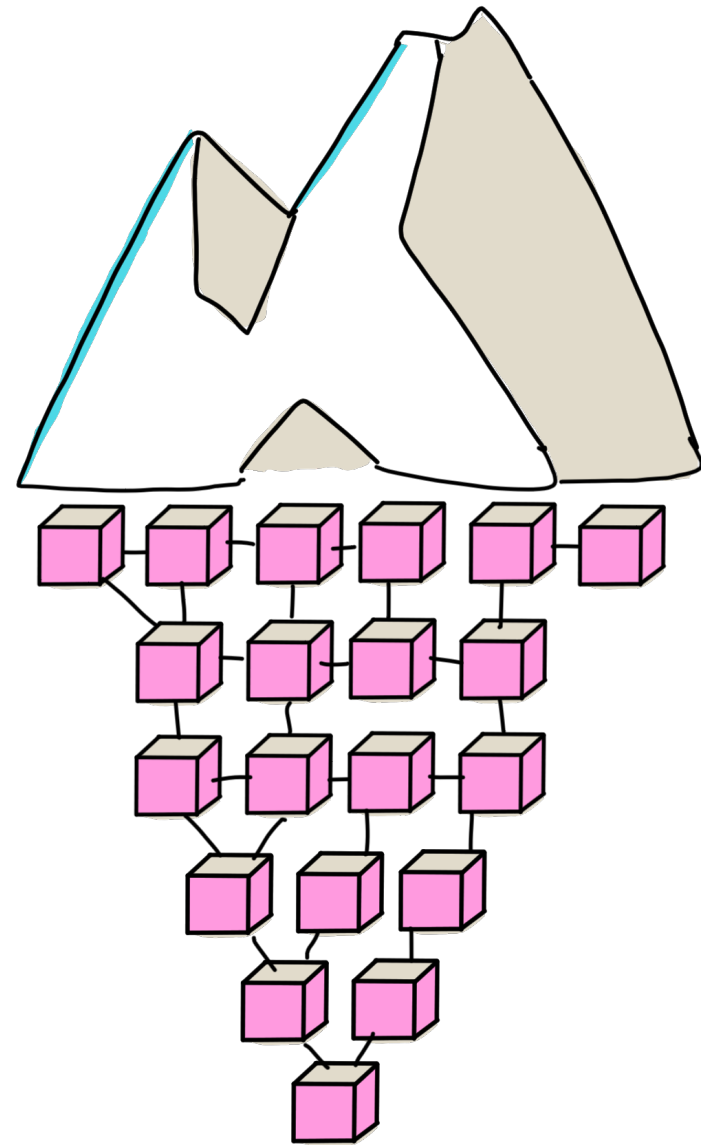
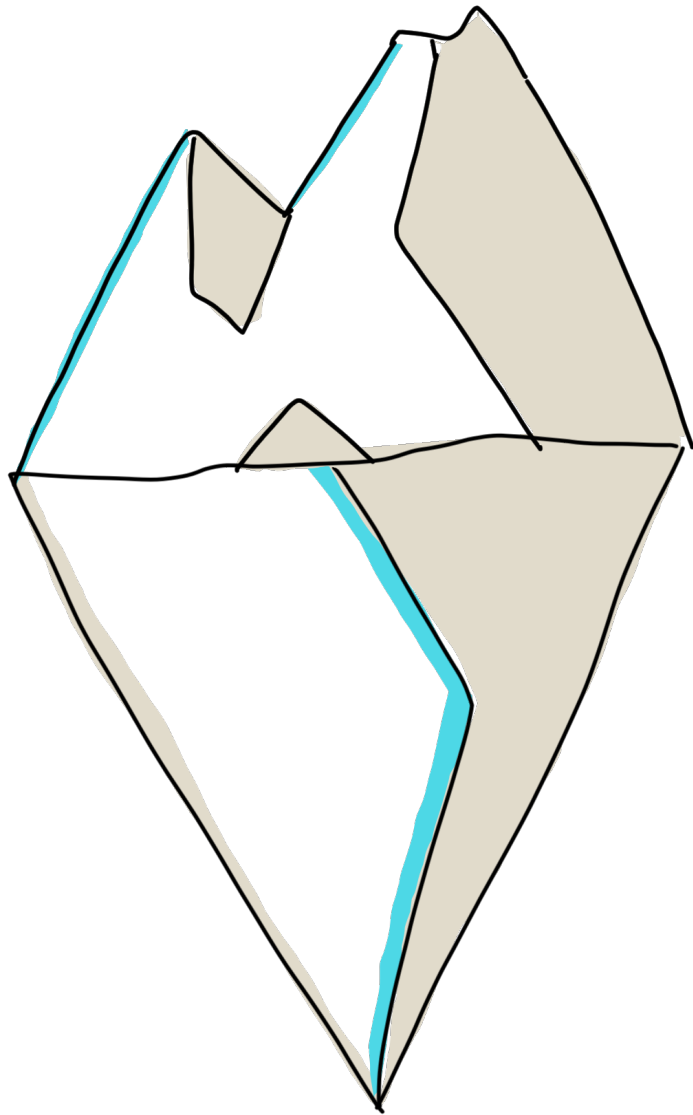

# DATA ROADMAP

## BUSINESS PRIORITIES

1



2

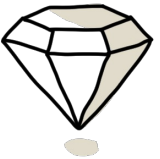

3



# DATA ROADMAP

BUSINESS  
PRIORITIES

DATA  
PRODUCTS

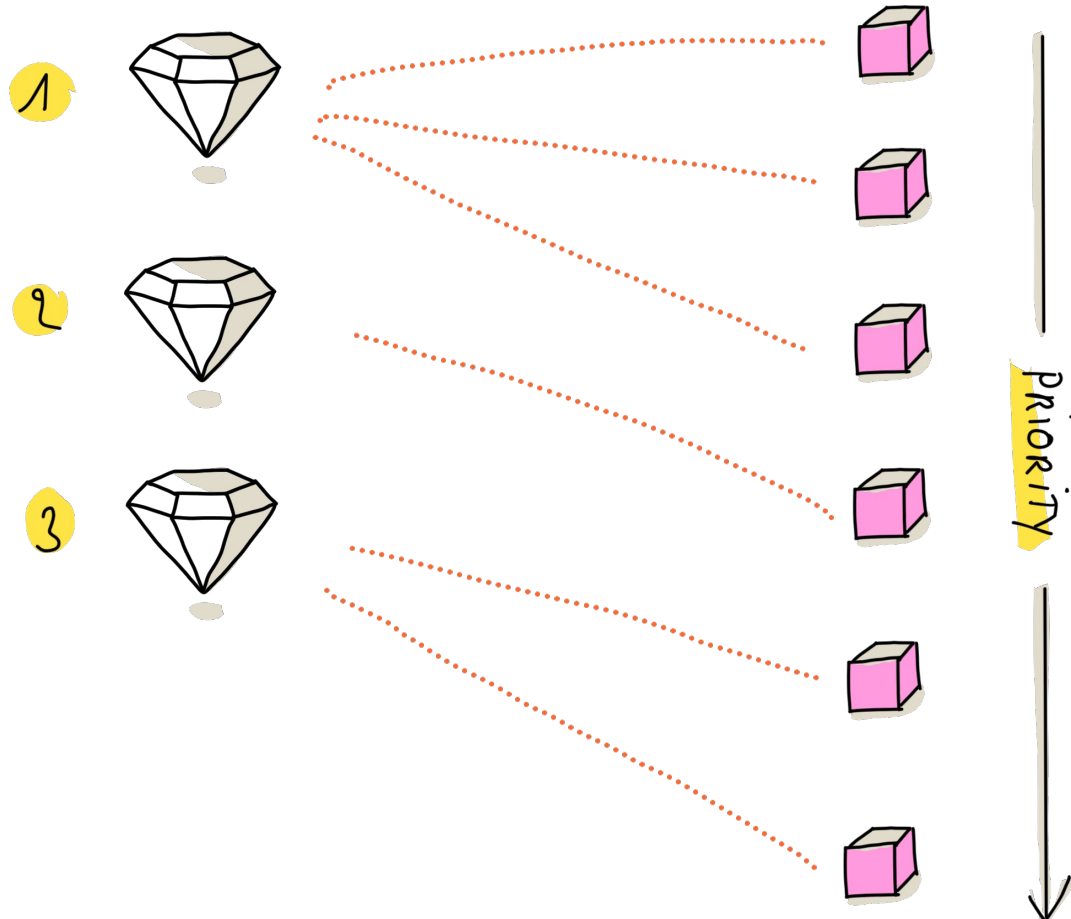

# DATA ROADMAP

## BUSINESS PRIORITIES

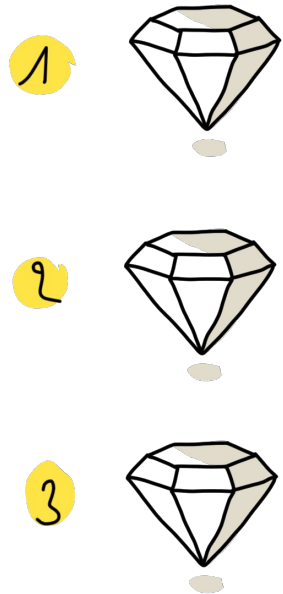

## DATA PRODUCTS



## DATA GOVERNANCE

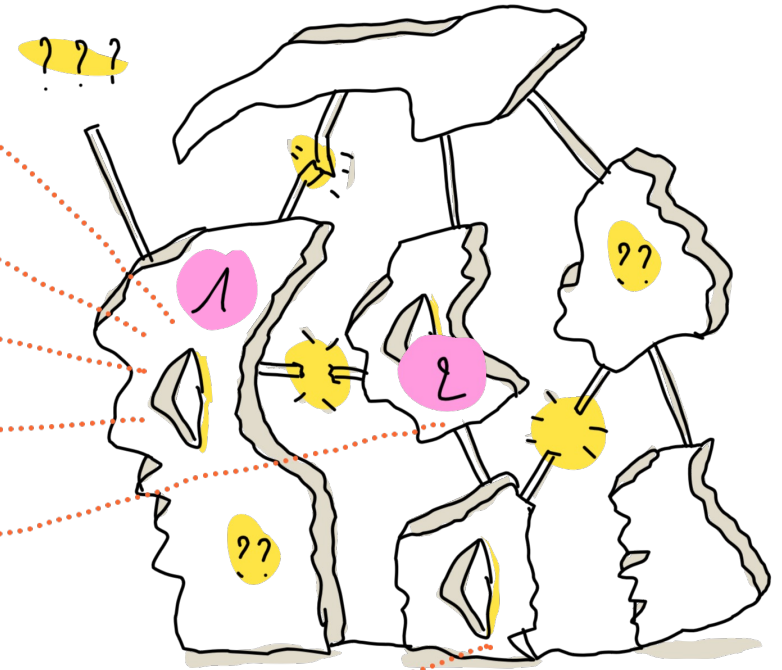

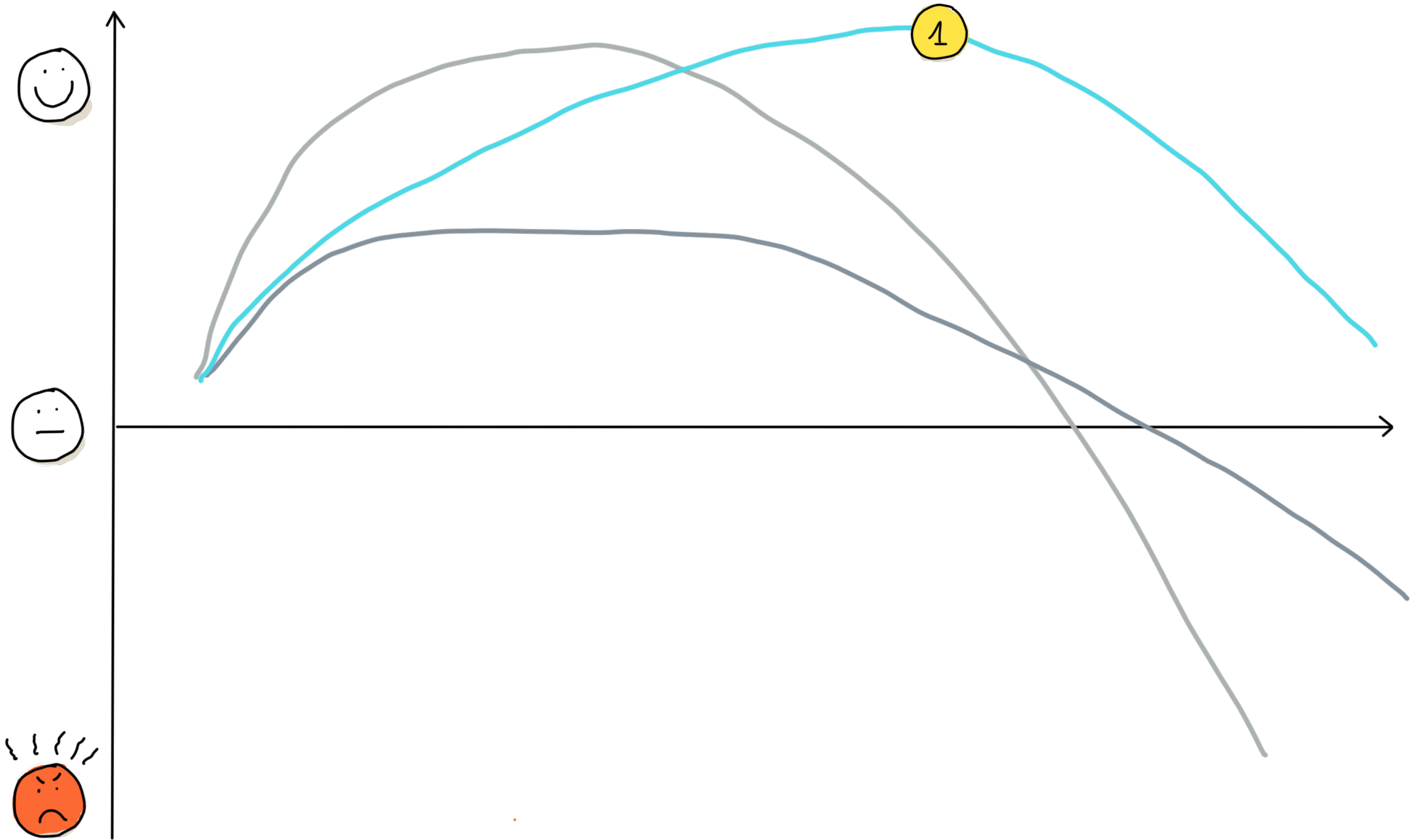

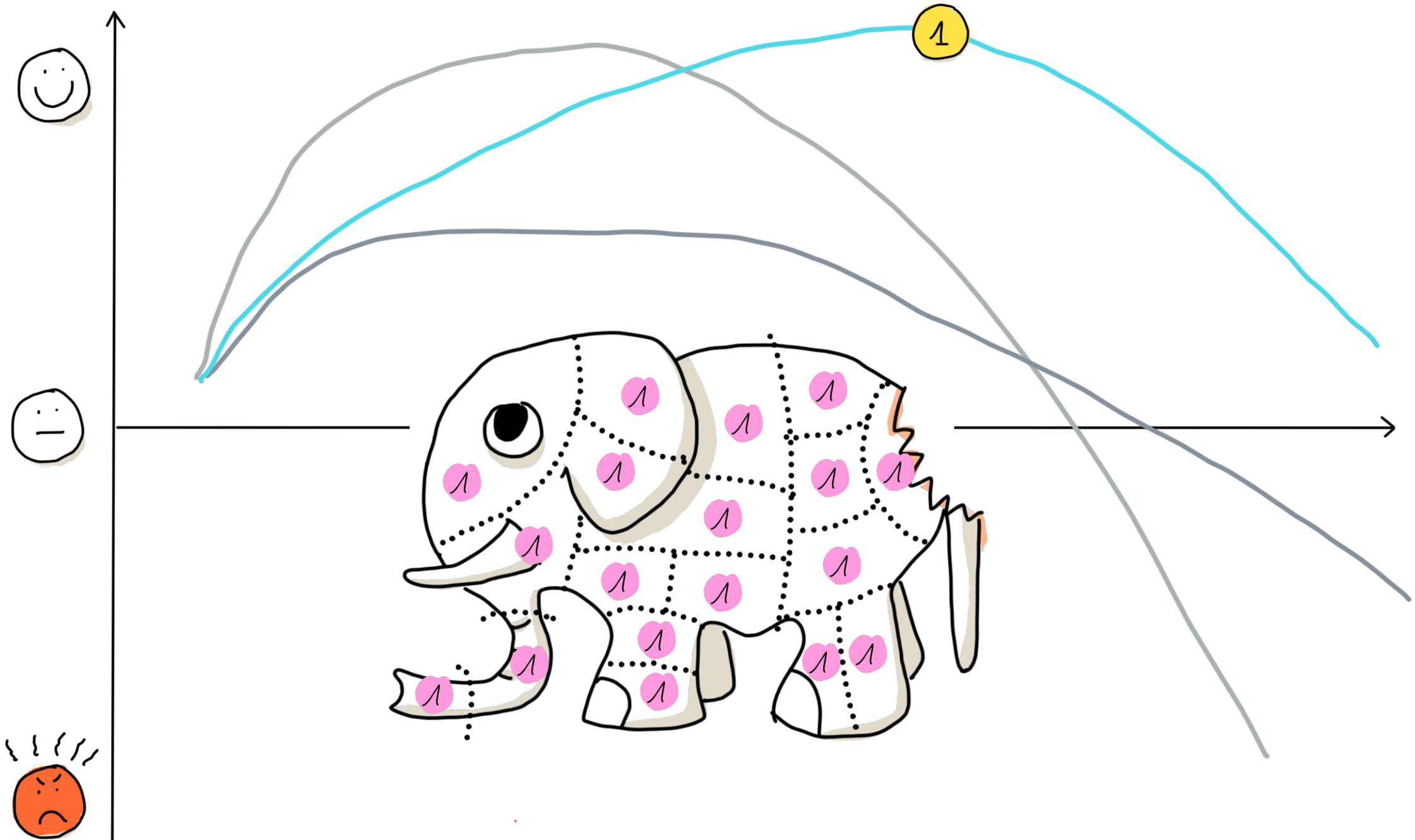

# MY JOURNEY TOWARDS VALUE FROM DATA

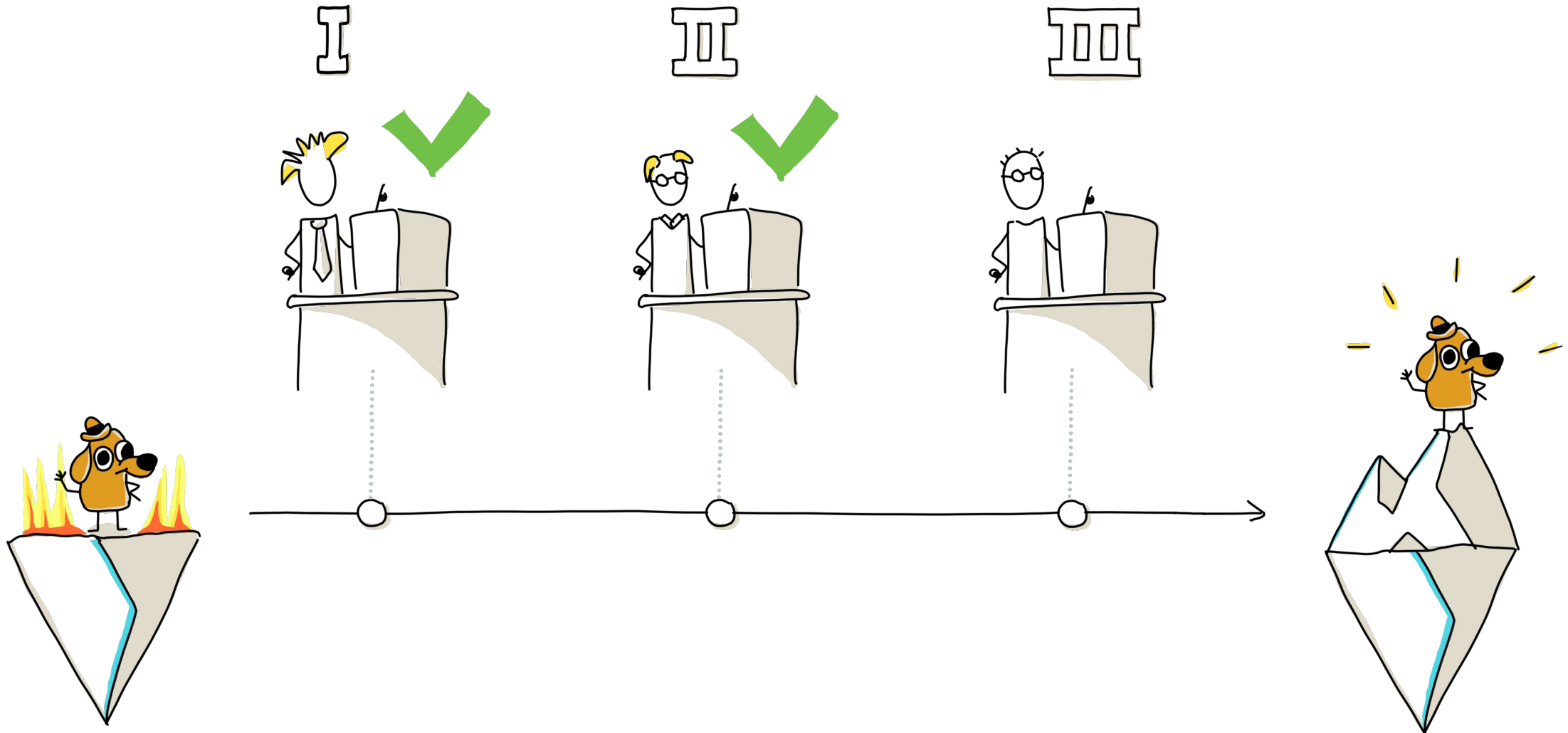

# THE DATA STRATEGY APPROACH

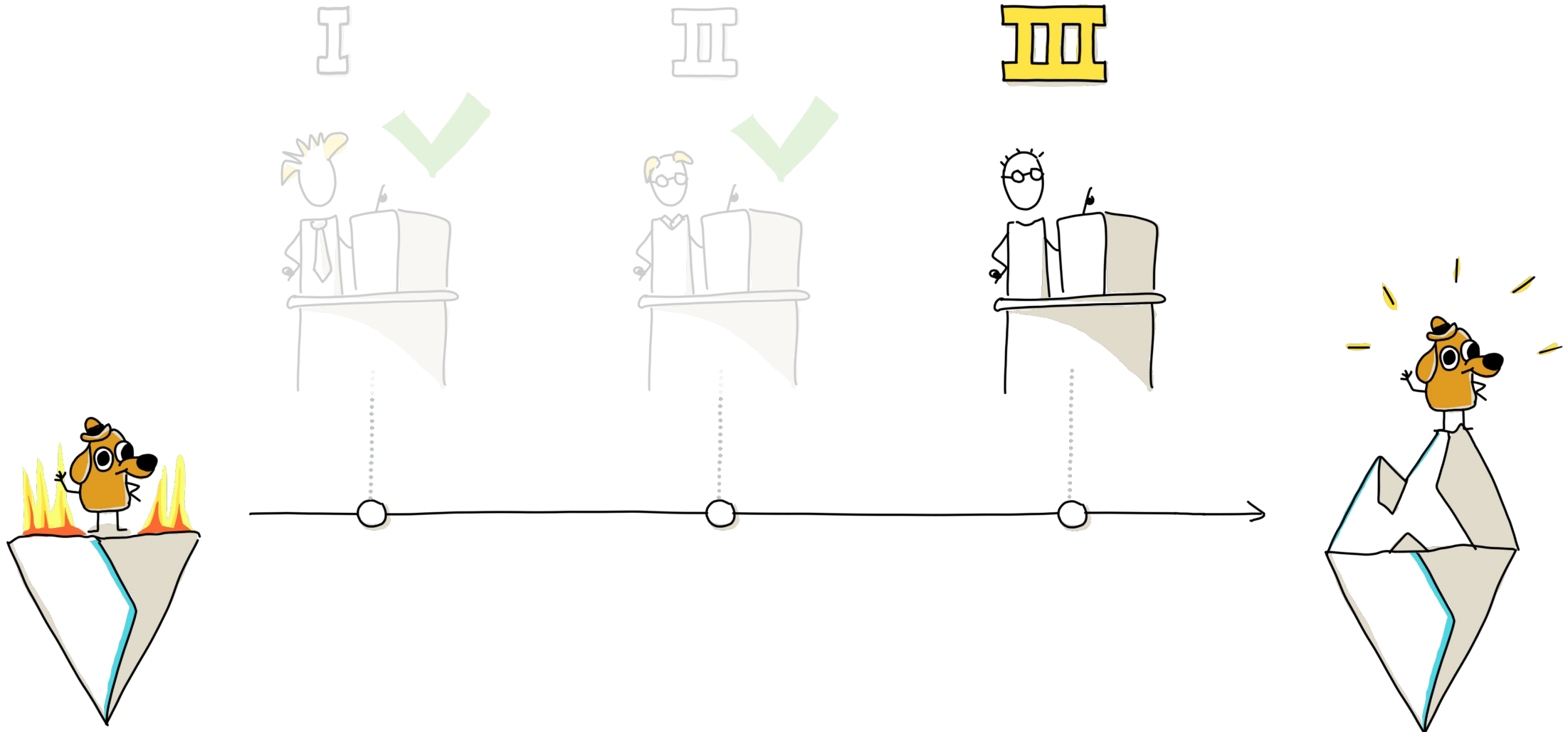

# LET'S SUMMARIZE FIRST

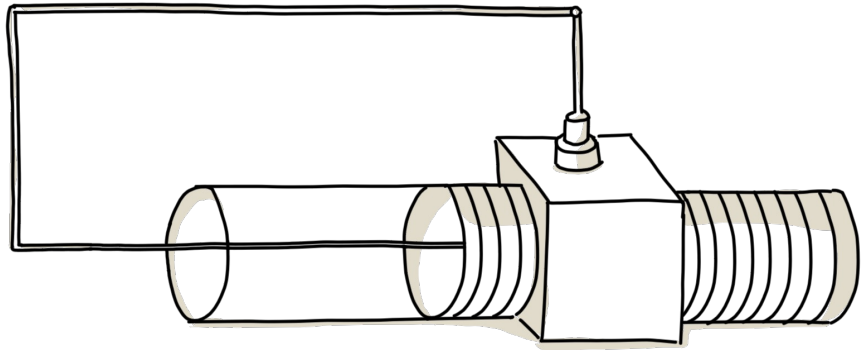

TECHNOLOGY



DATA



PEOPLE

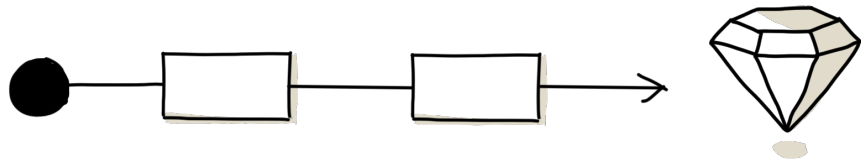

PROCESS

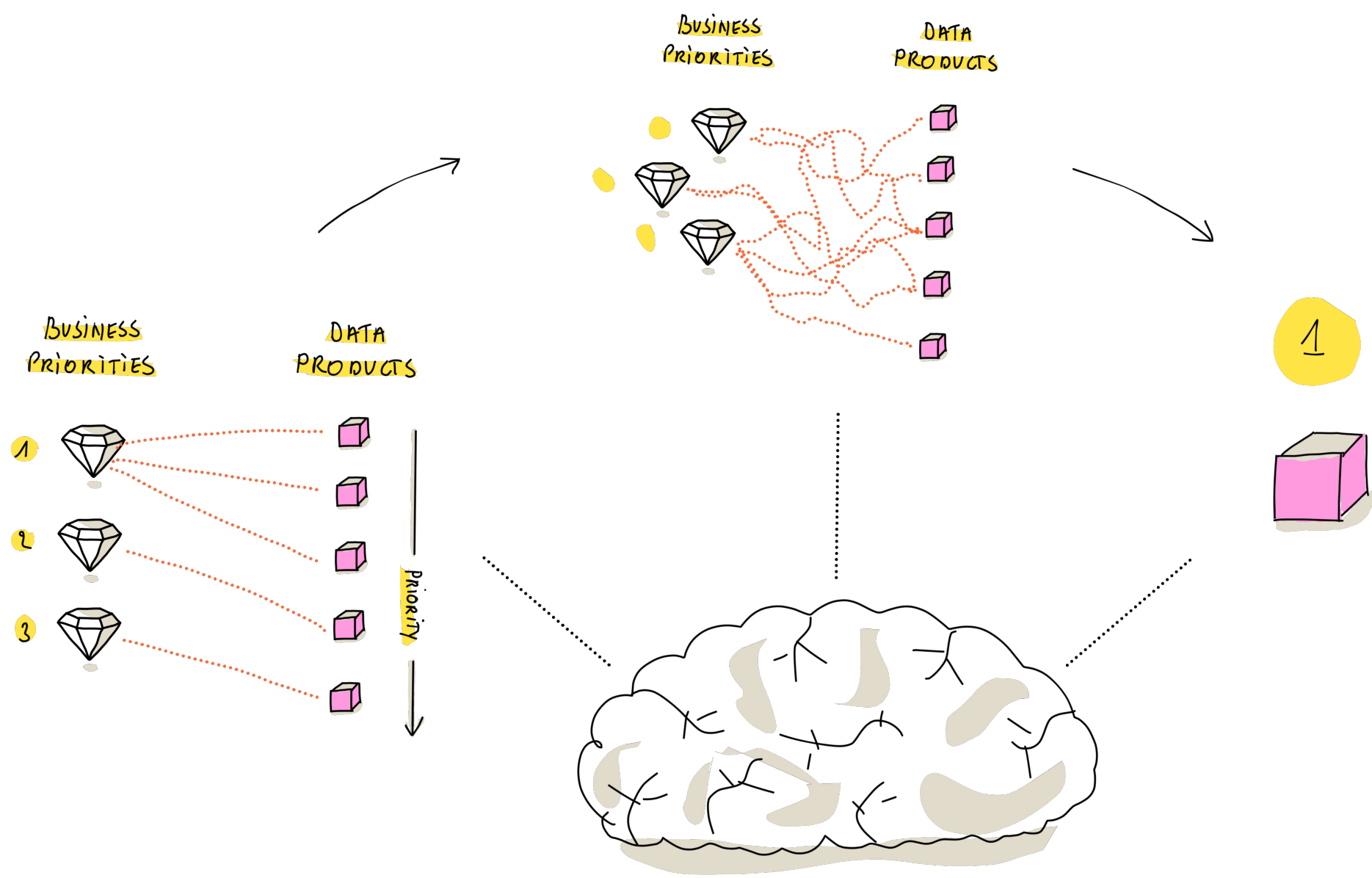

# WE NEED MORE THAN A DATA ROADMAP

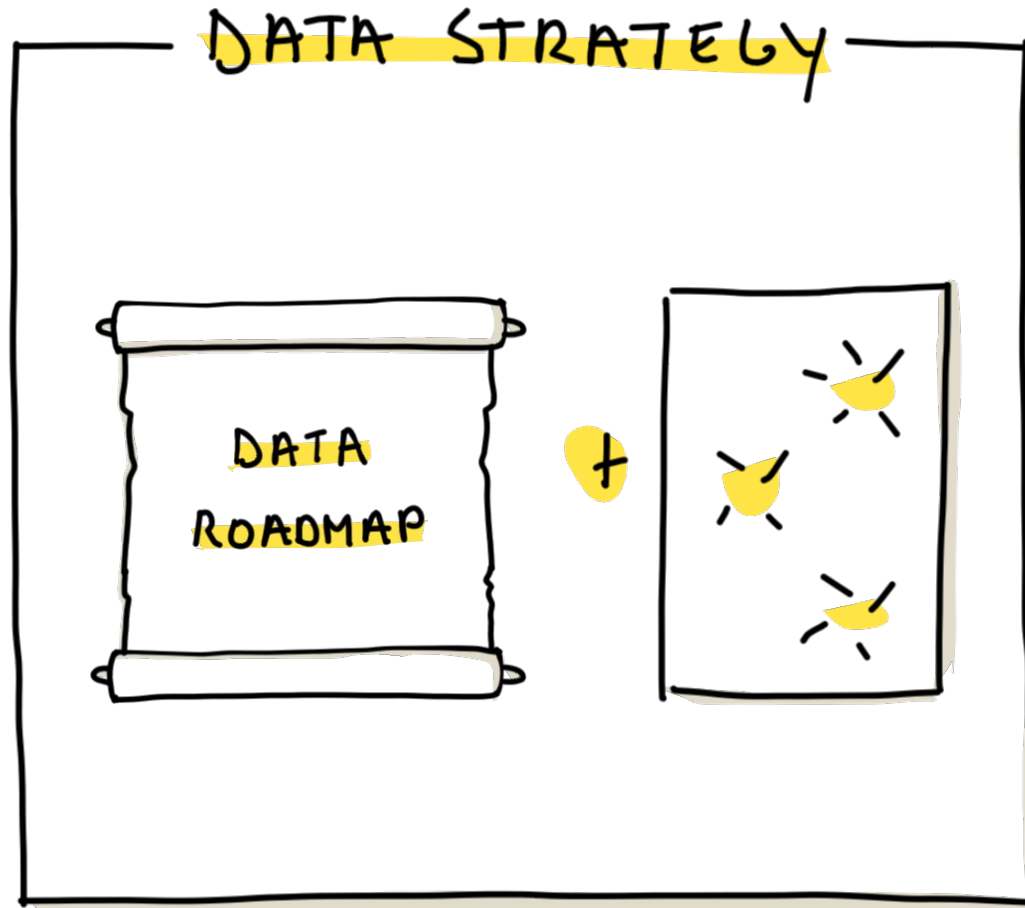

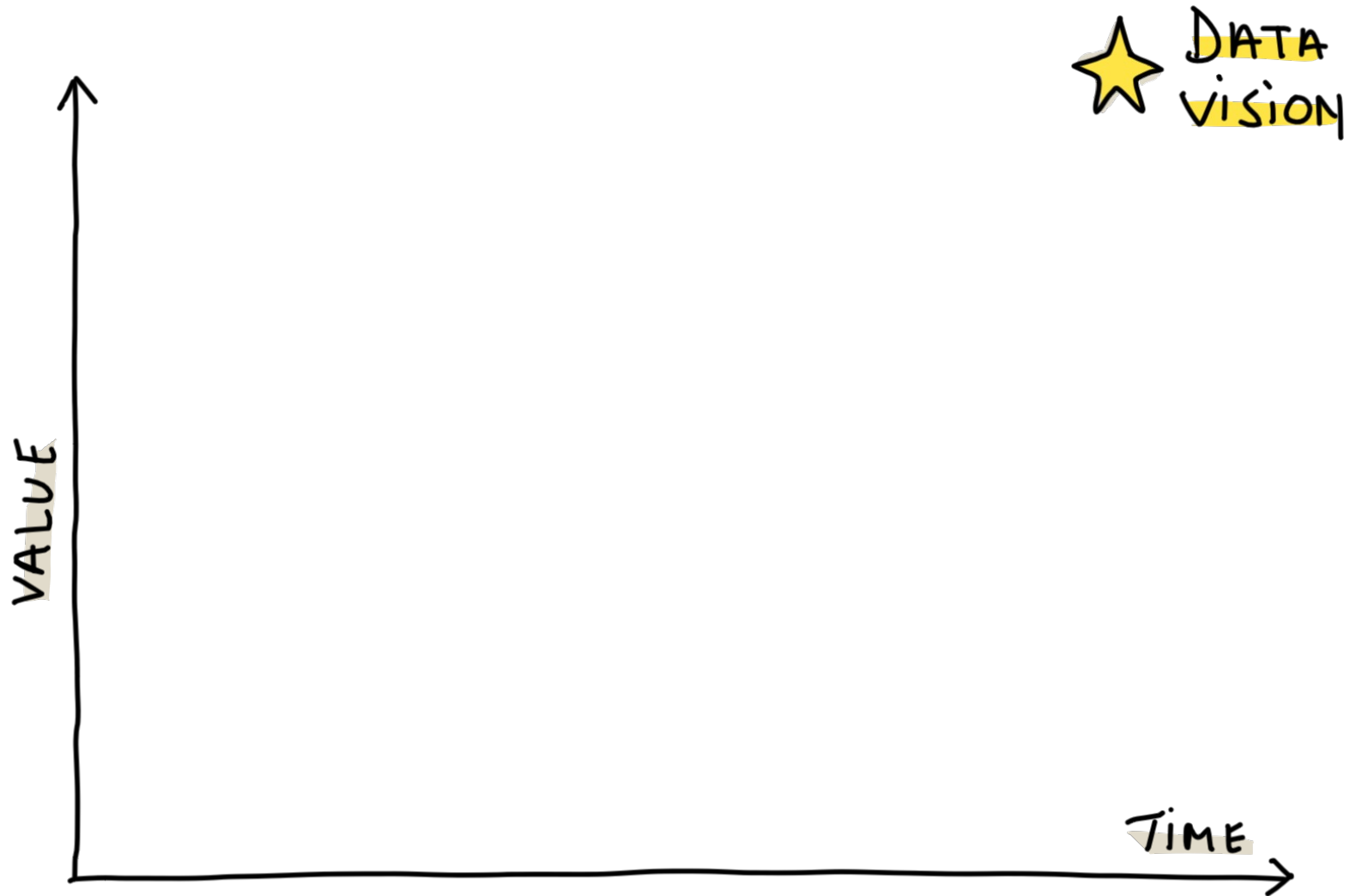

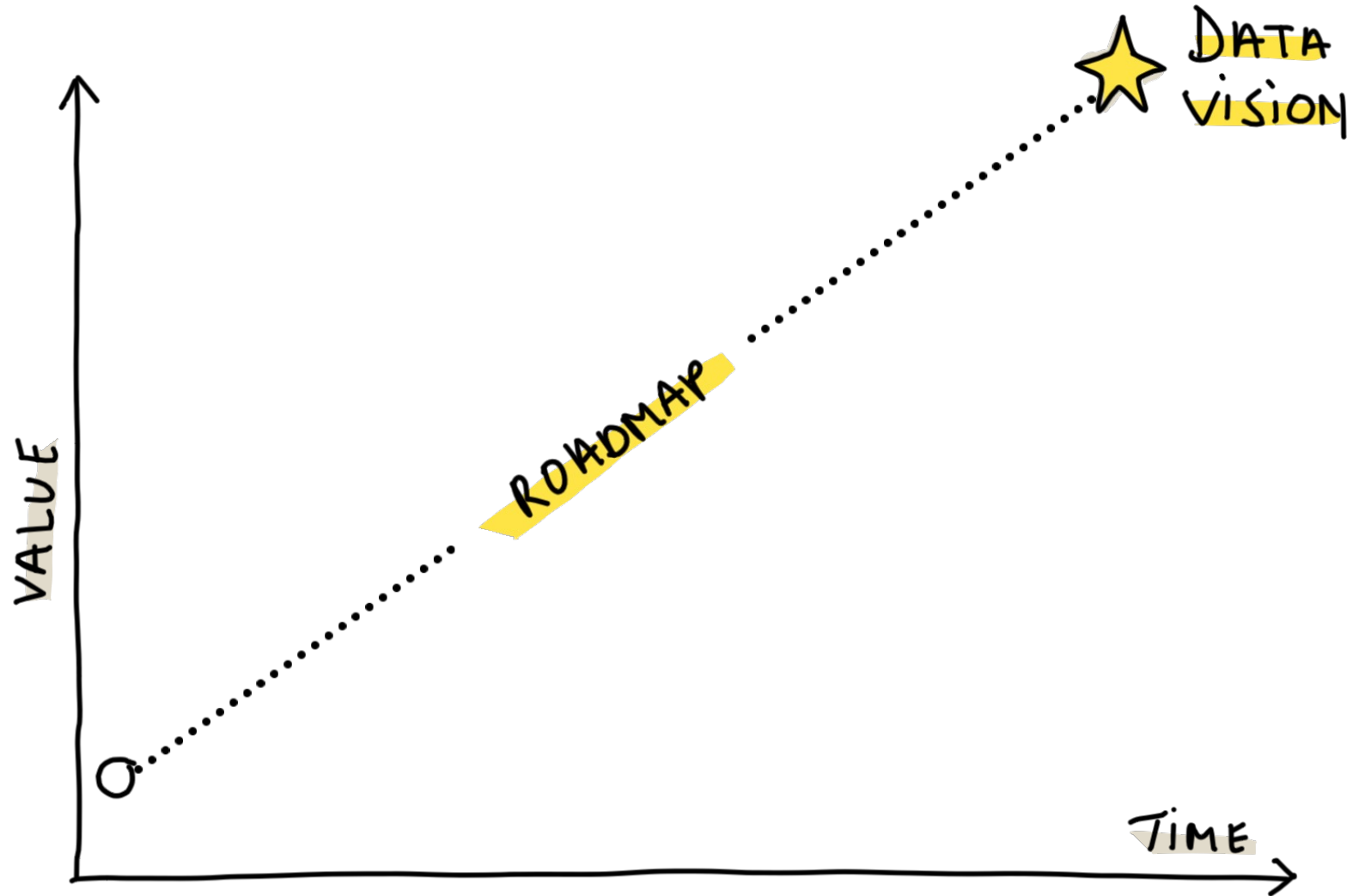

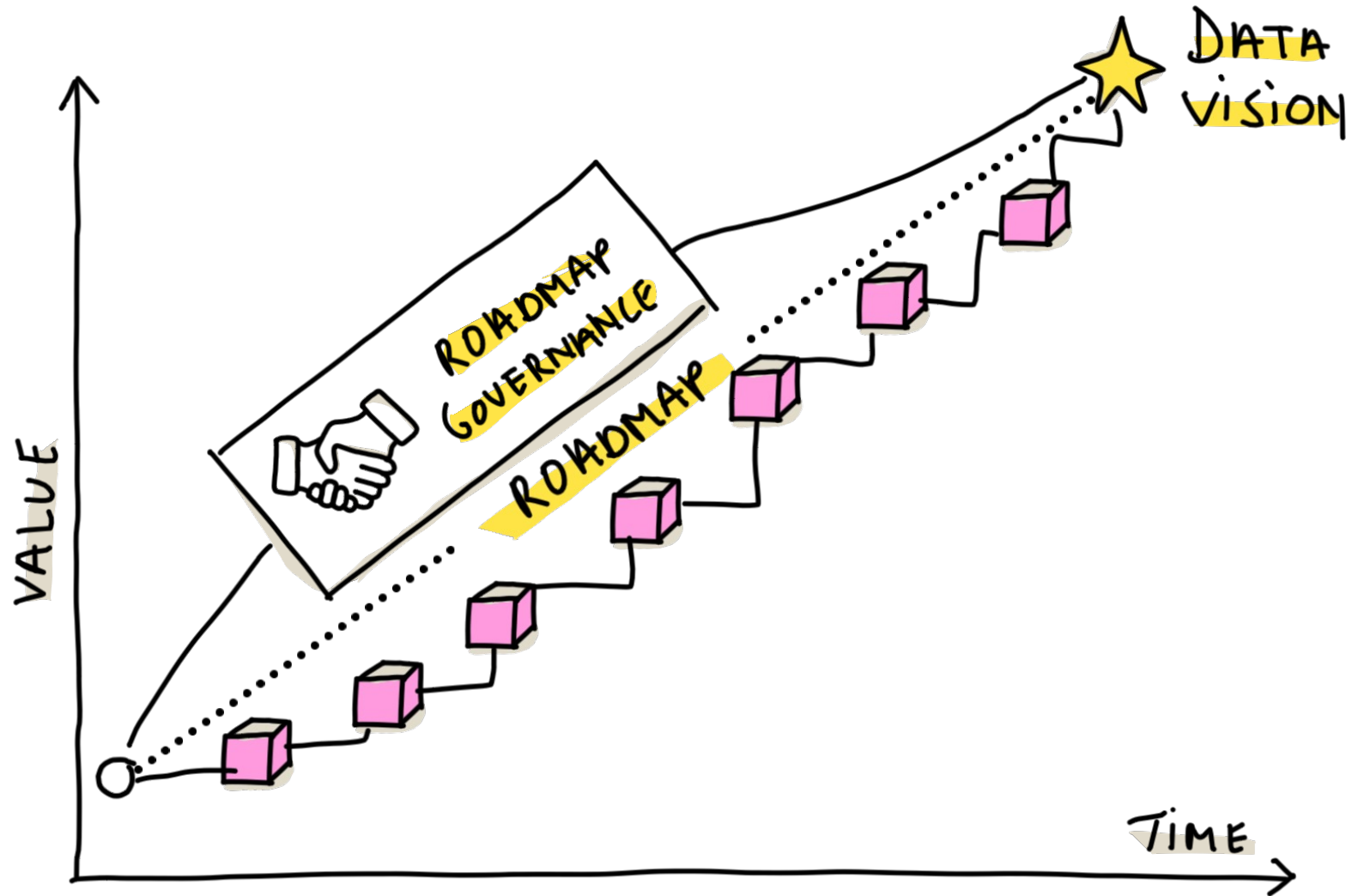

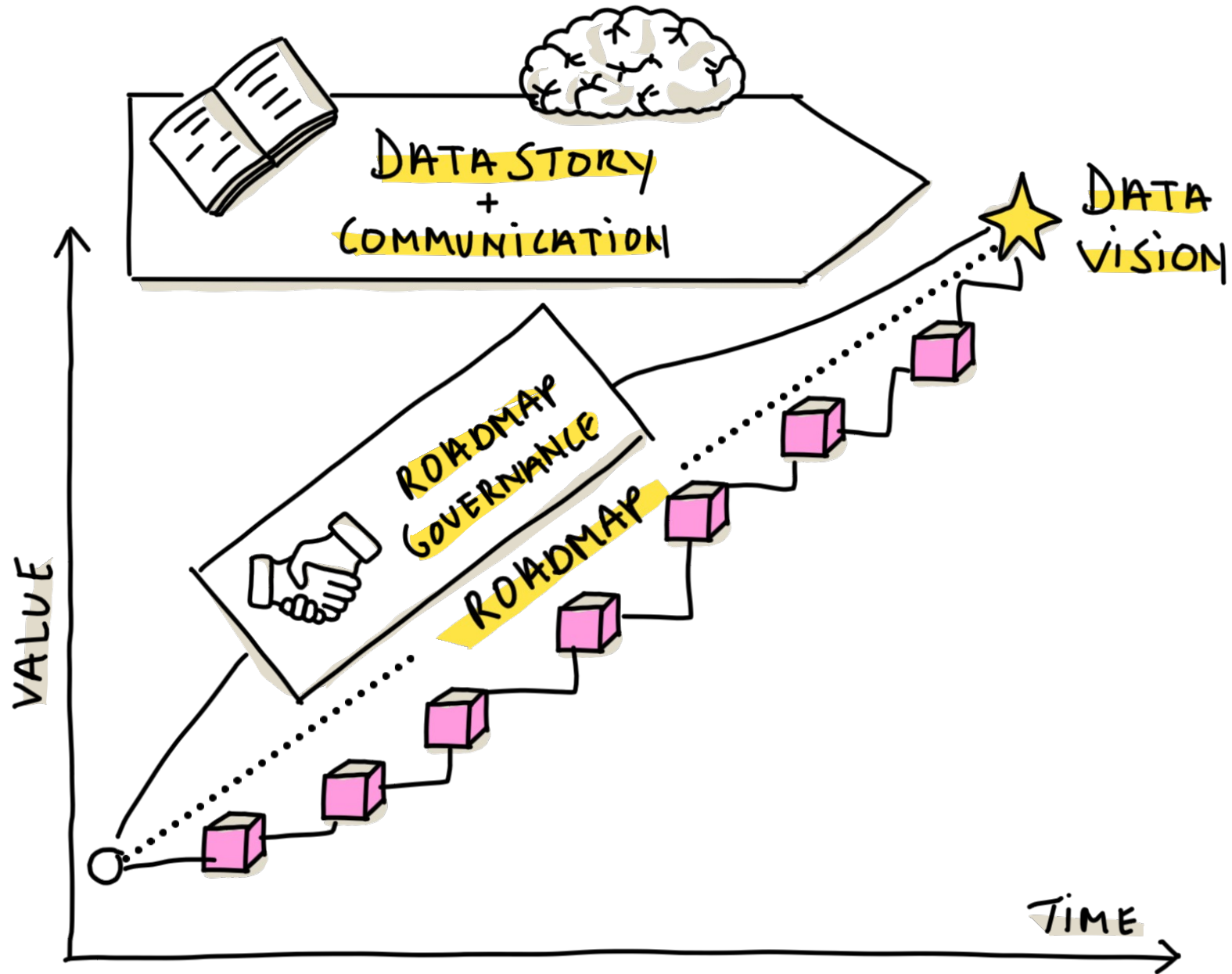

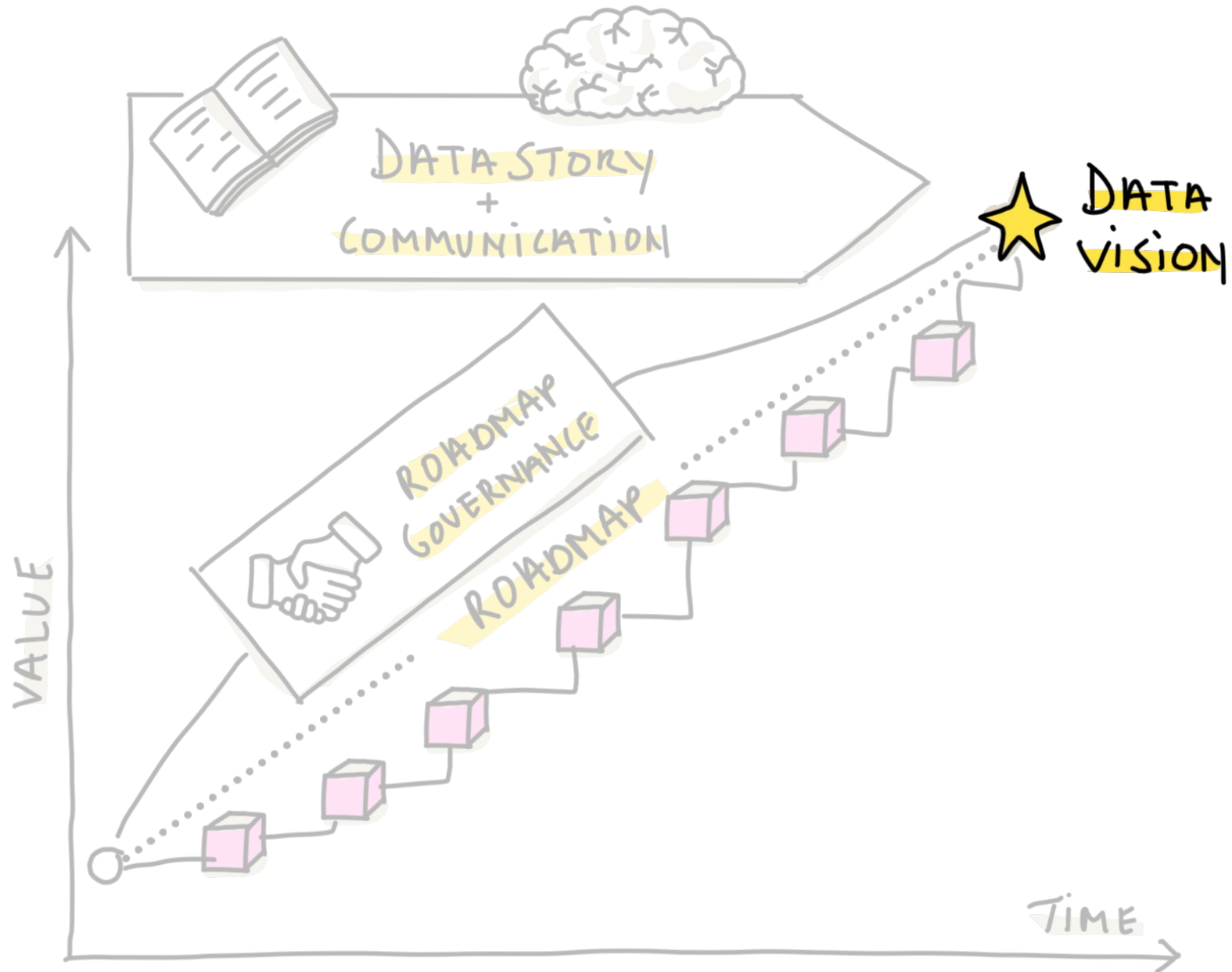

## BUSINESS GOALS

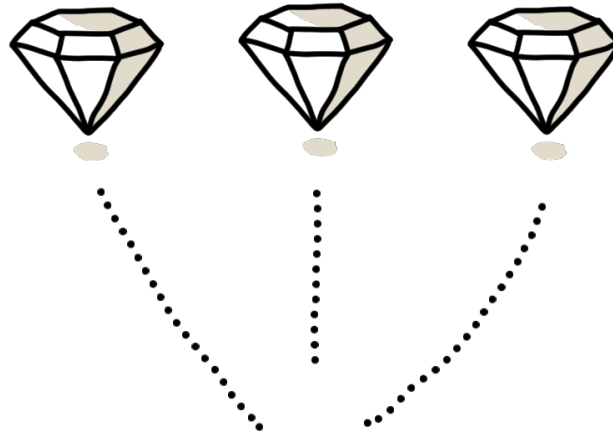

To harness the power of data and AI to drive **smarter, proactive decisions** that create lasting **competitive advantage** and a **future-ready business**.

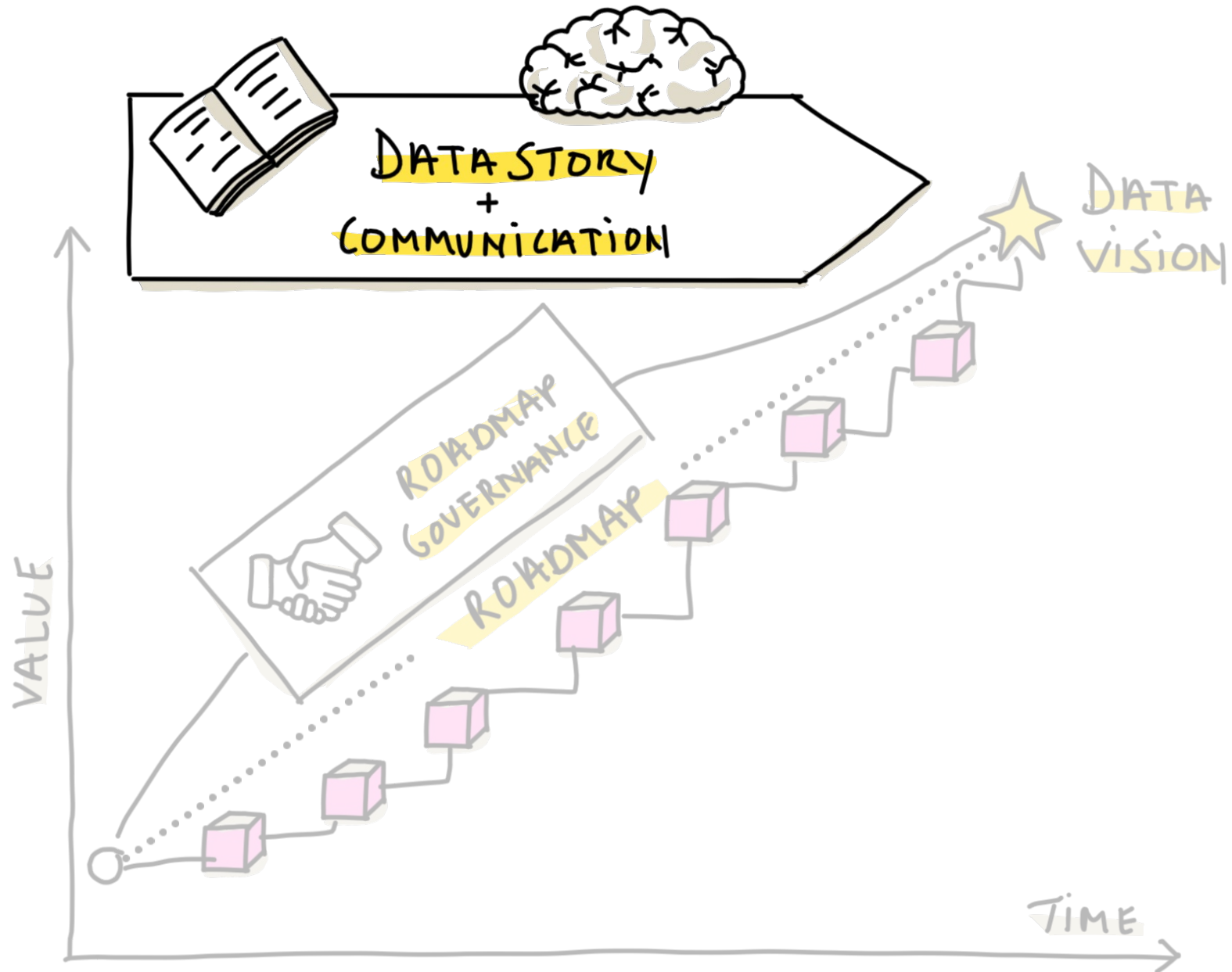

★  
DATA VISION

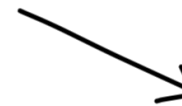
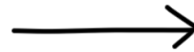
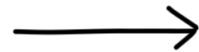

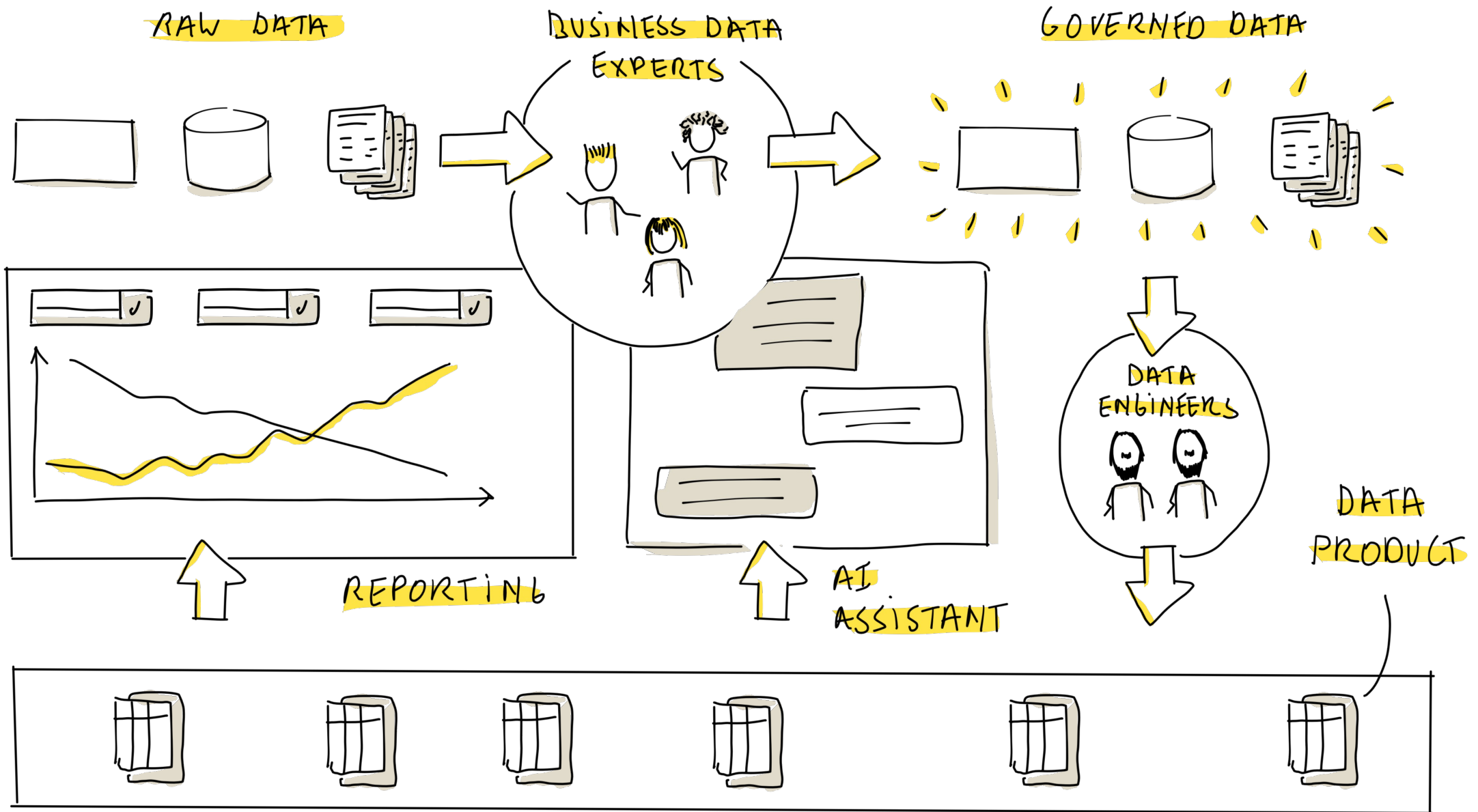

**DATA PLATFORM**

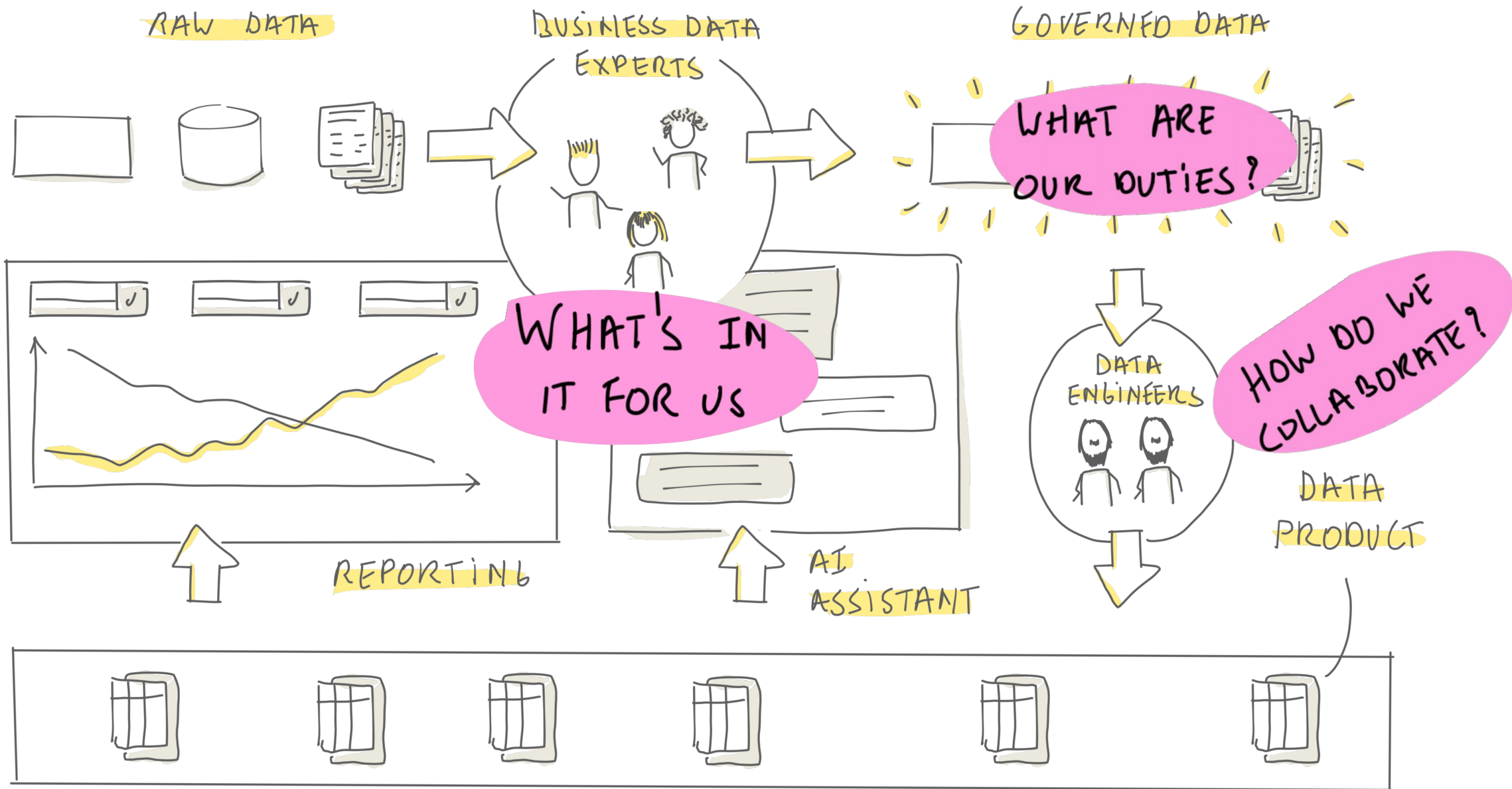

**DATA PLATFORM**

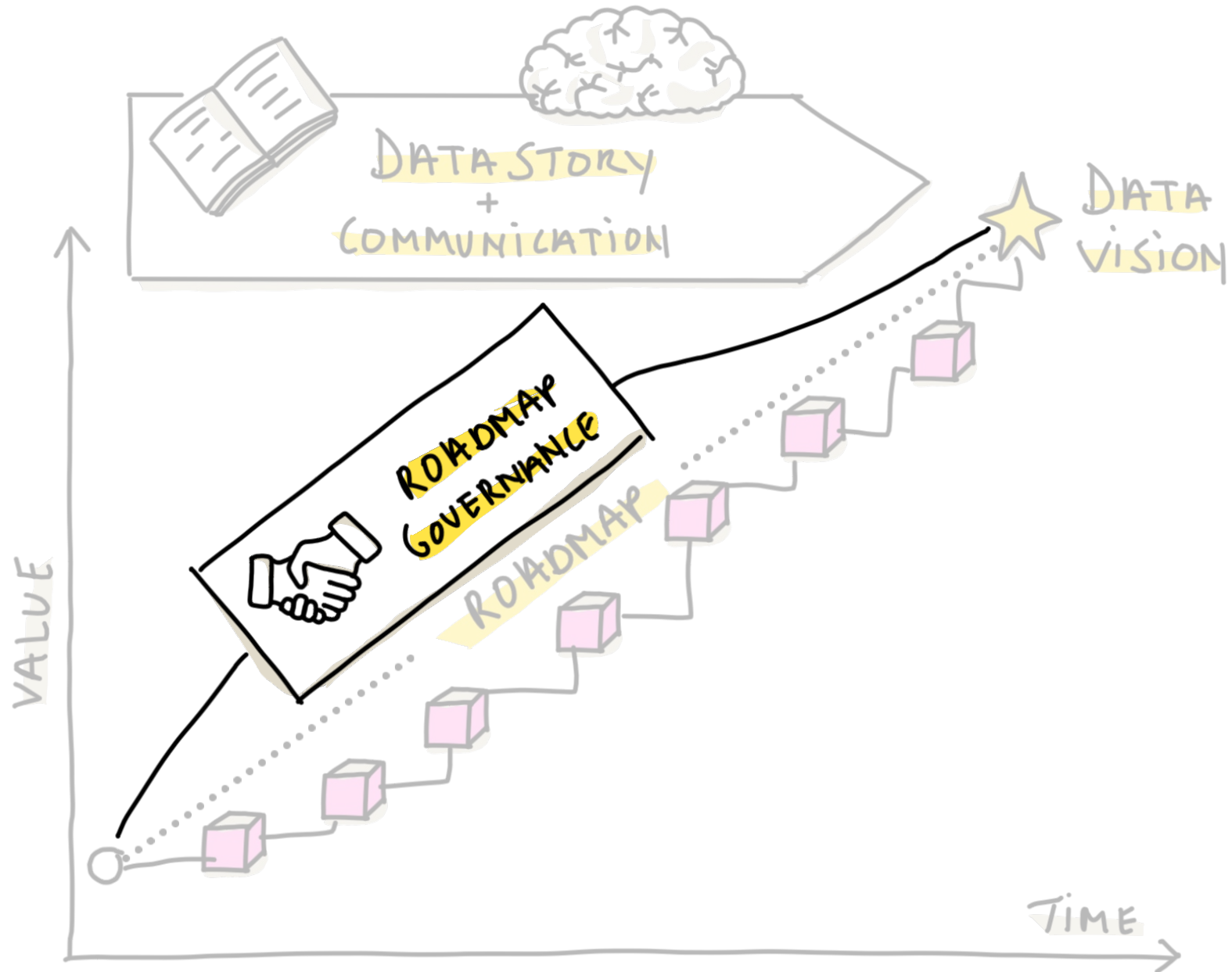

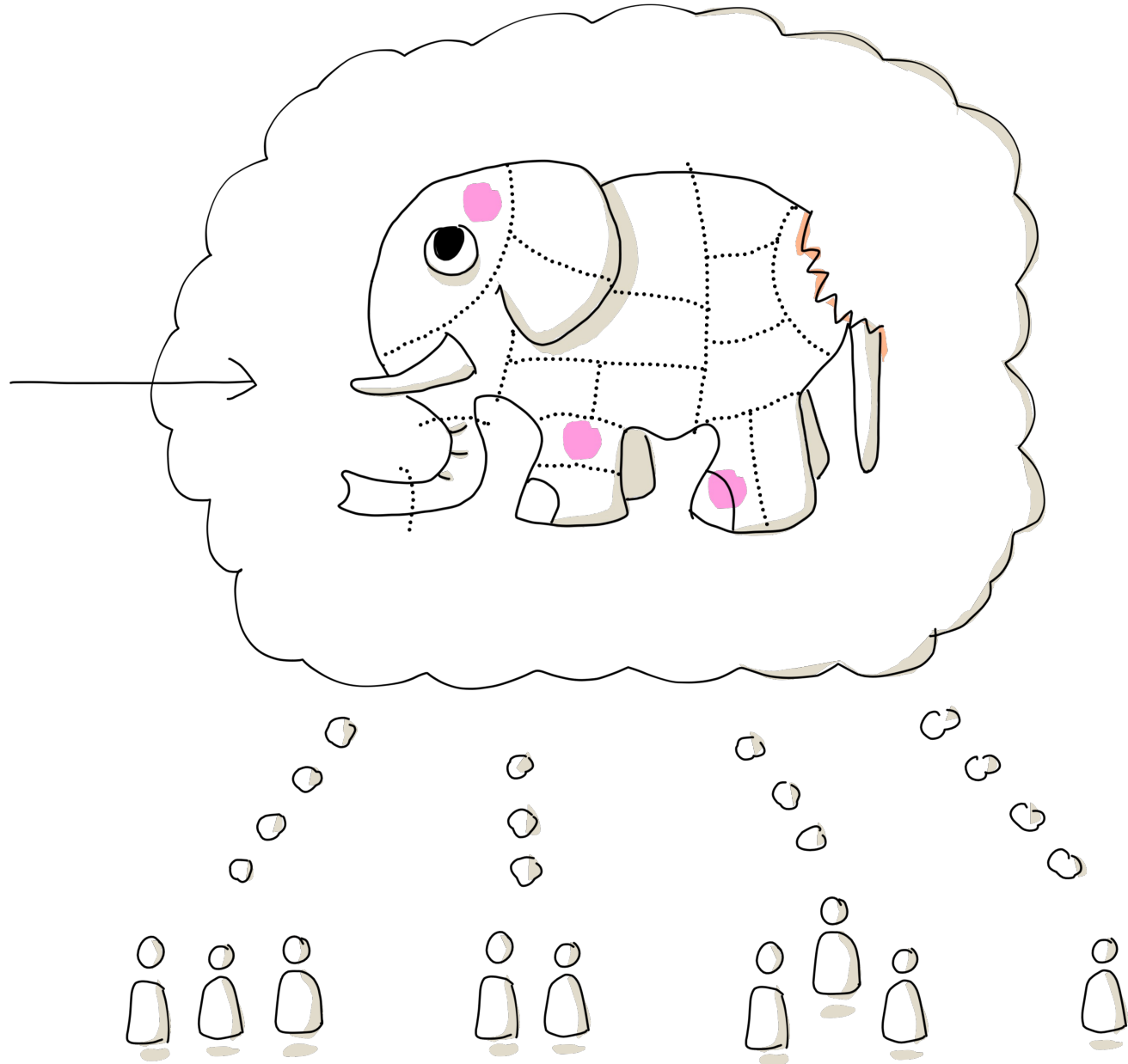
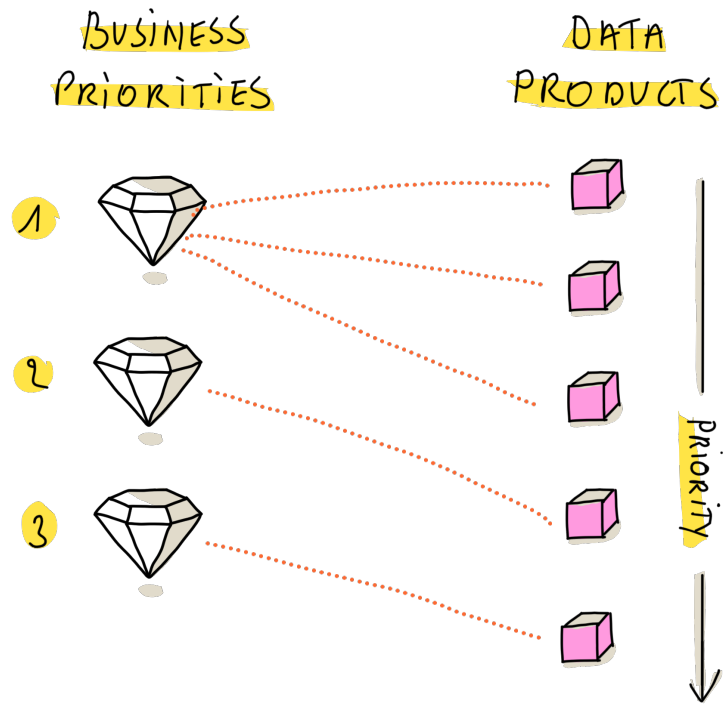

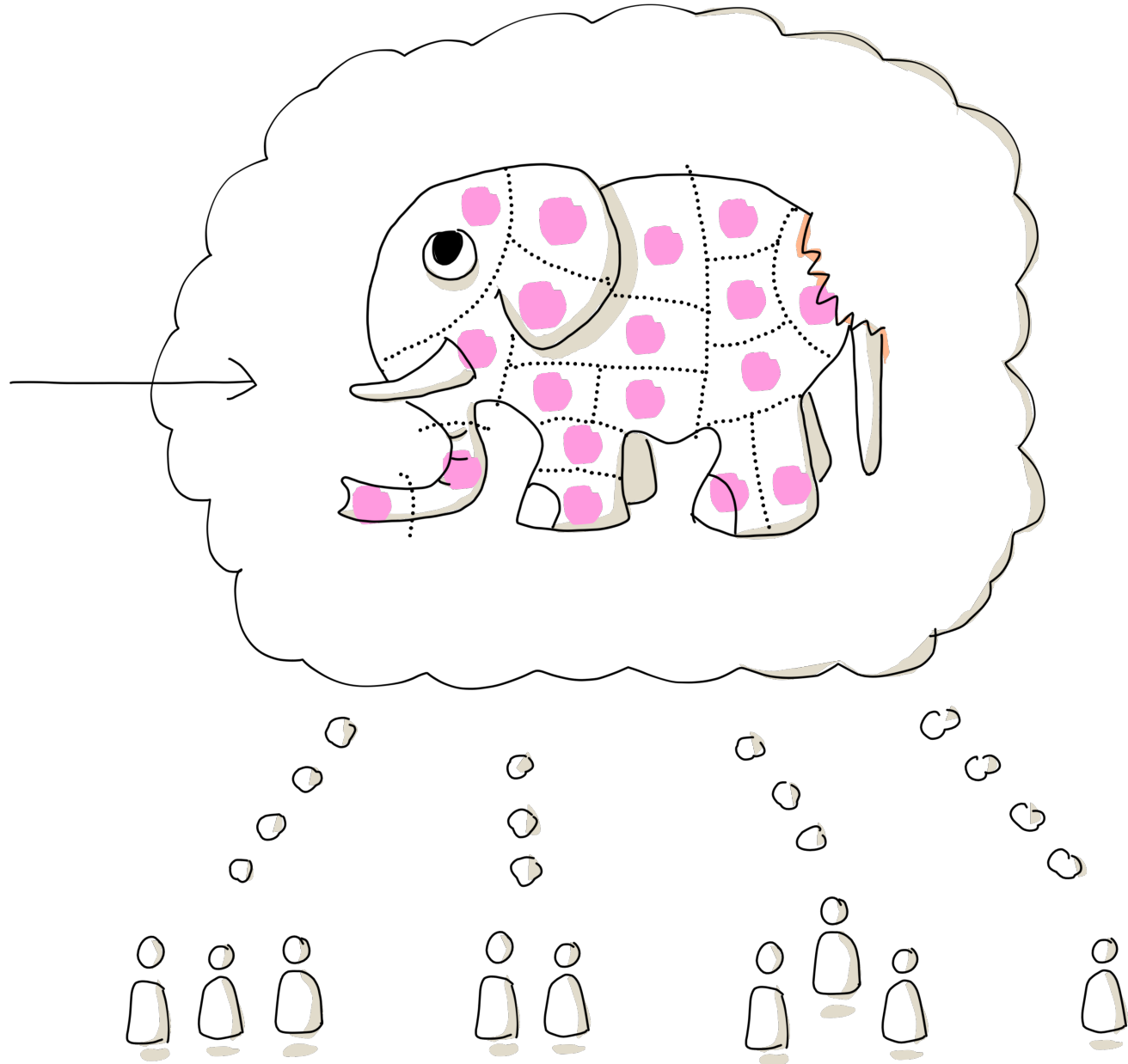
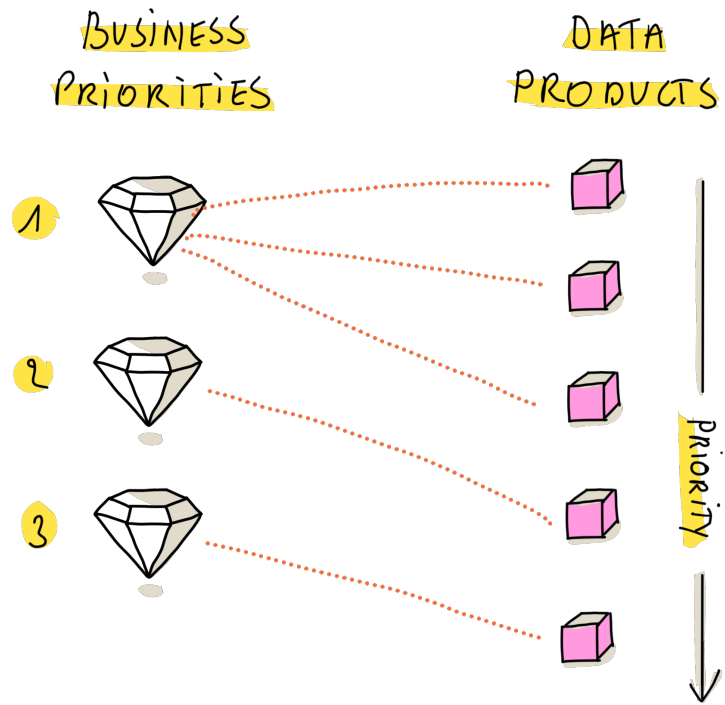

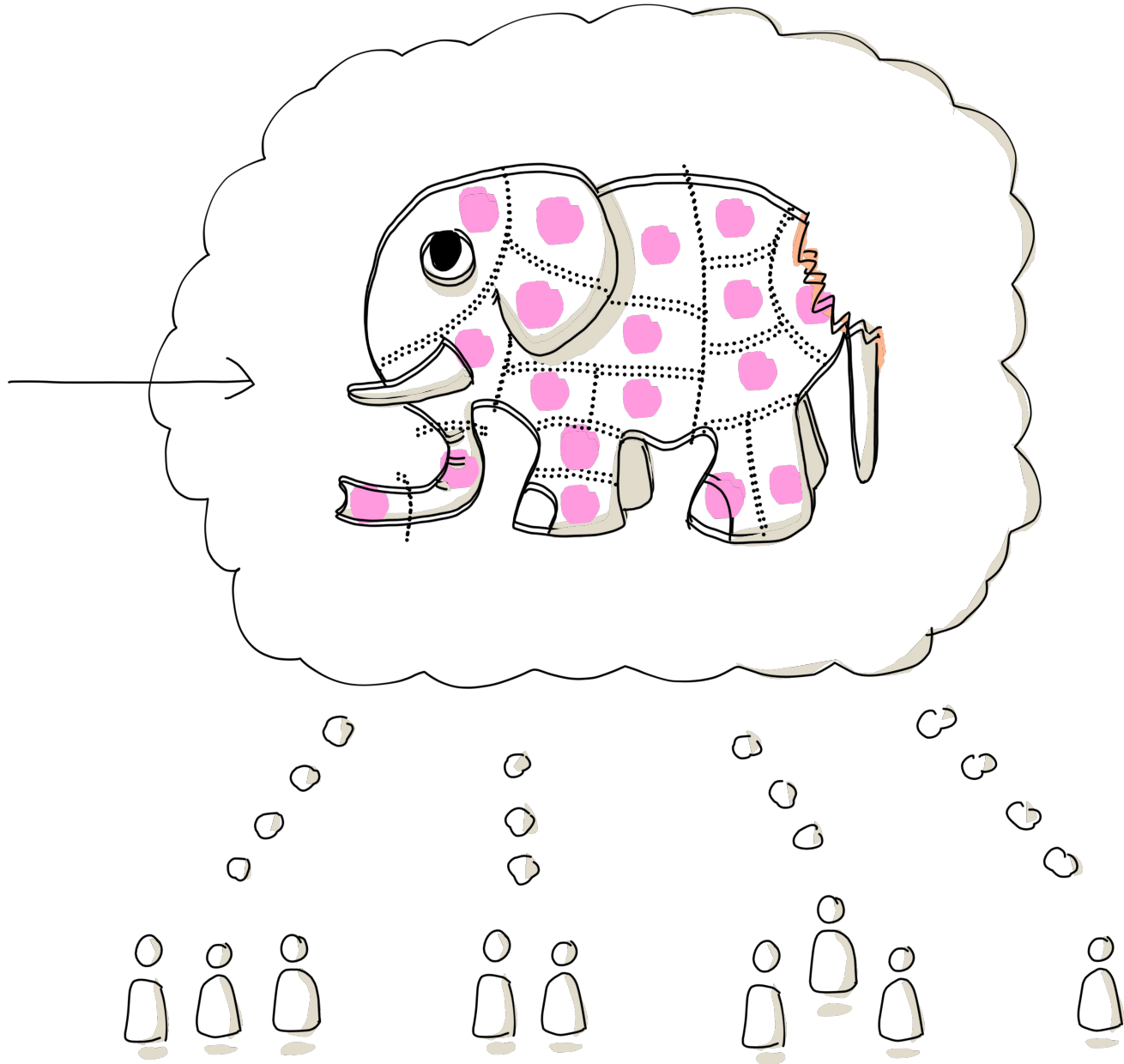
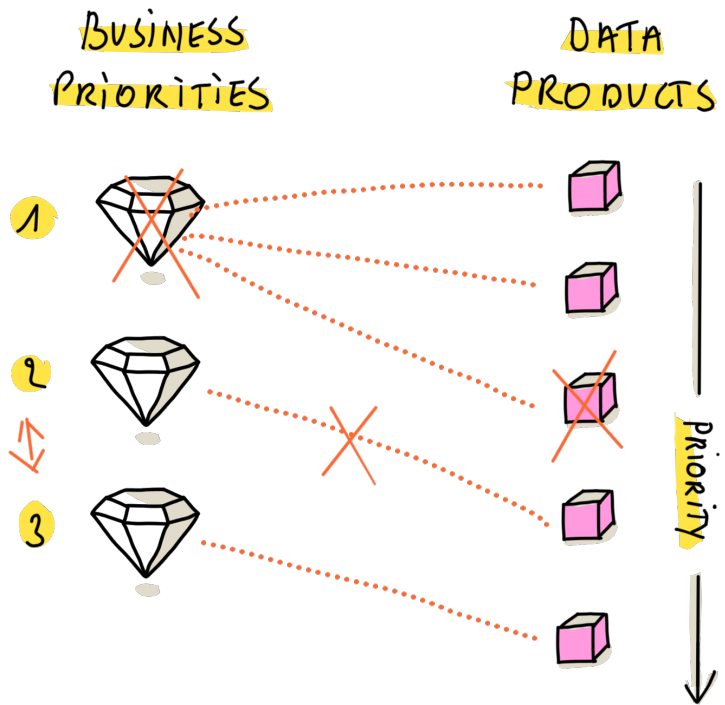

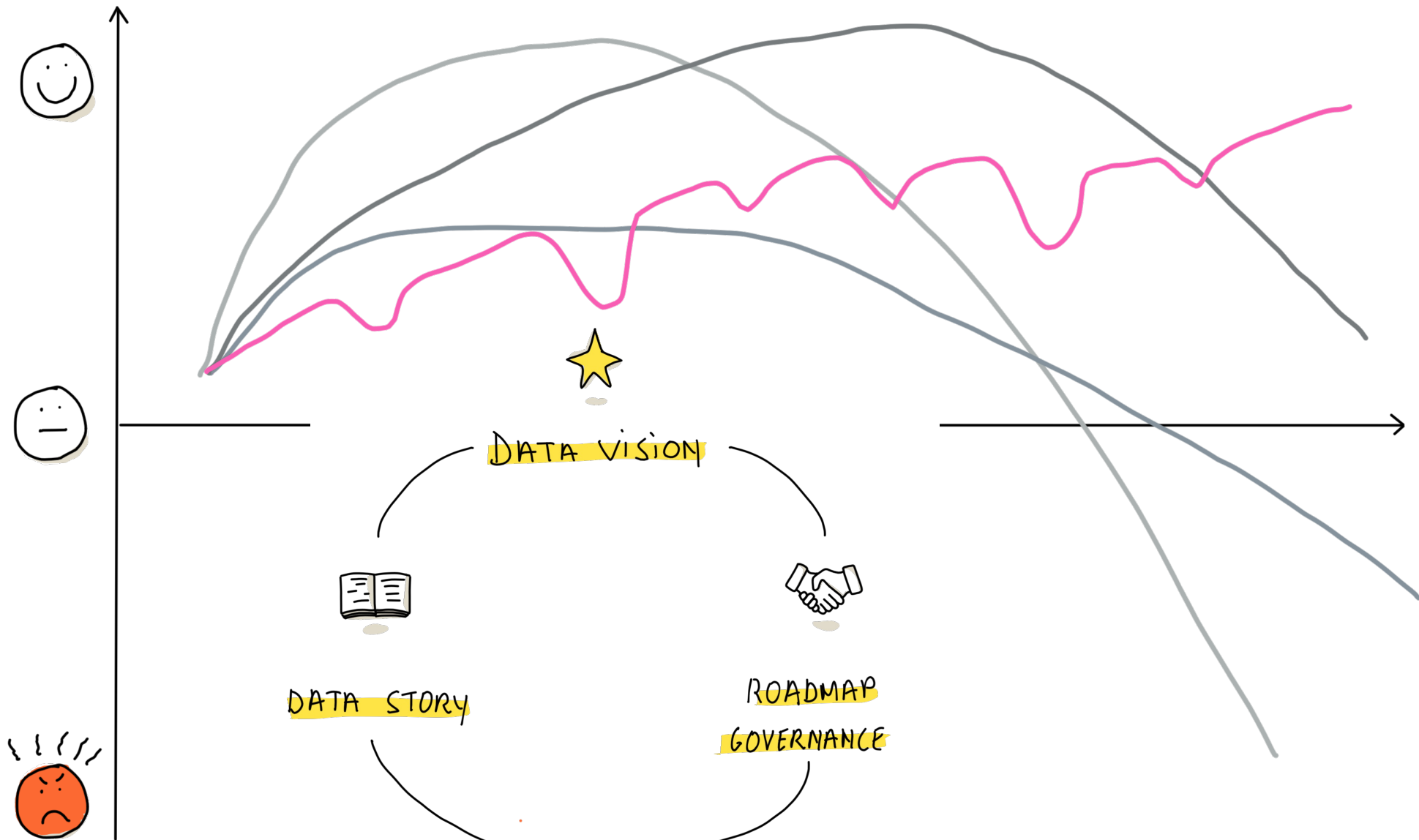

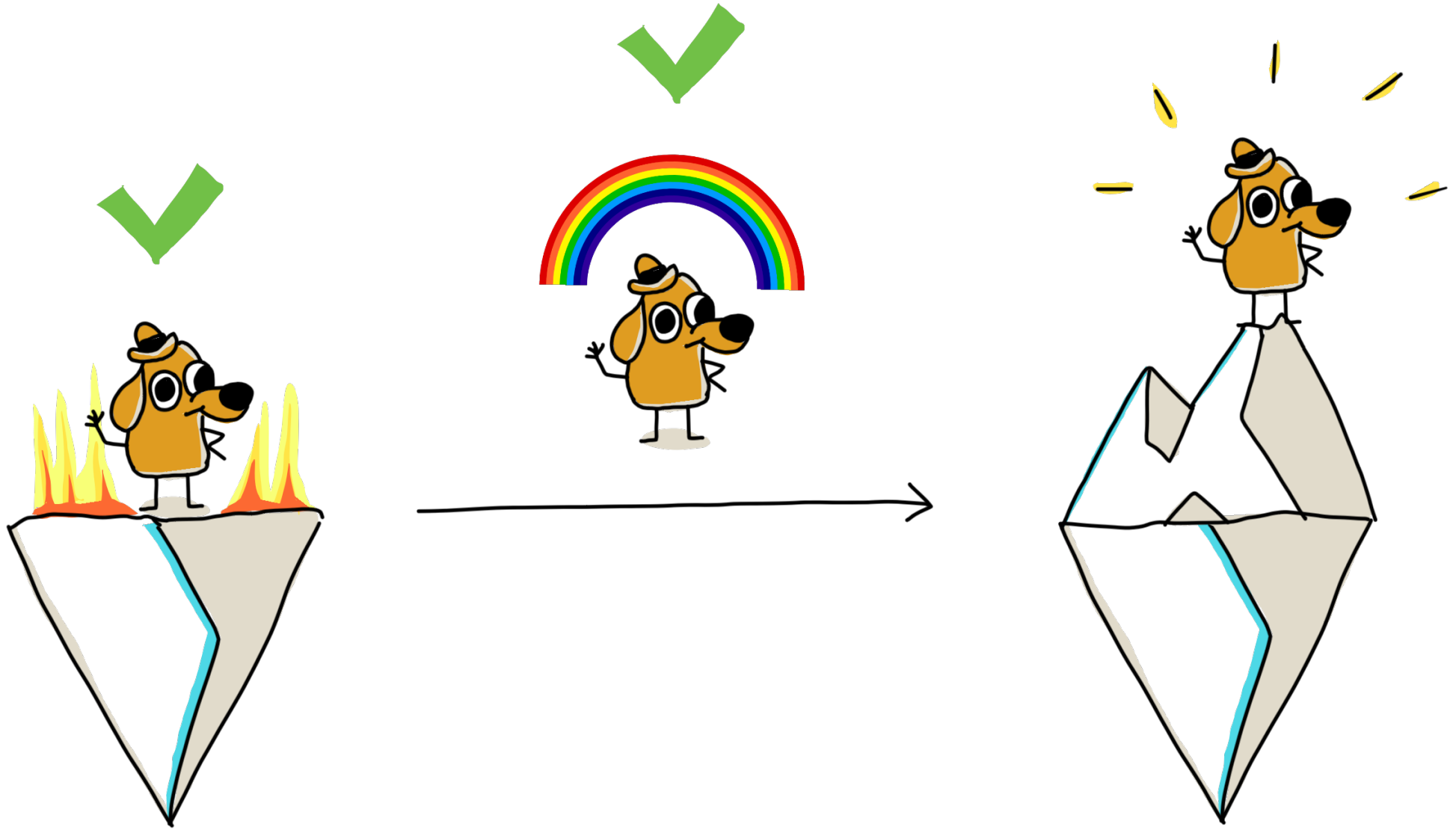

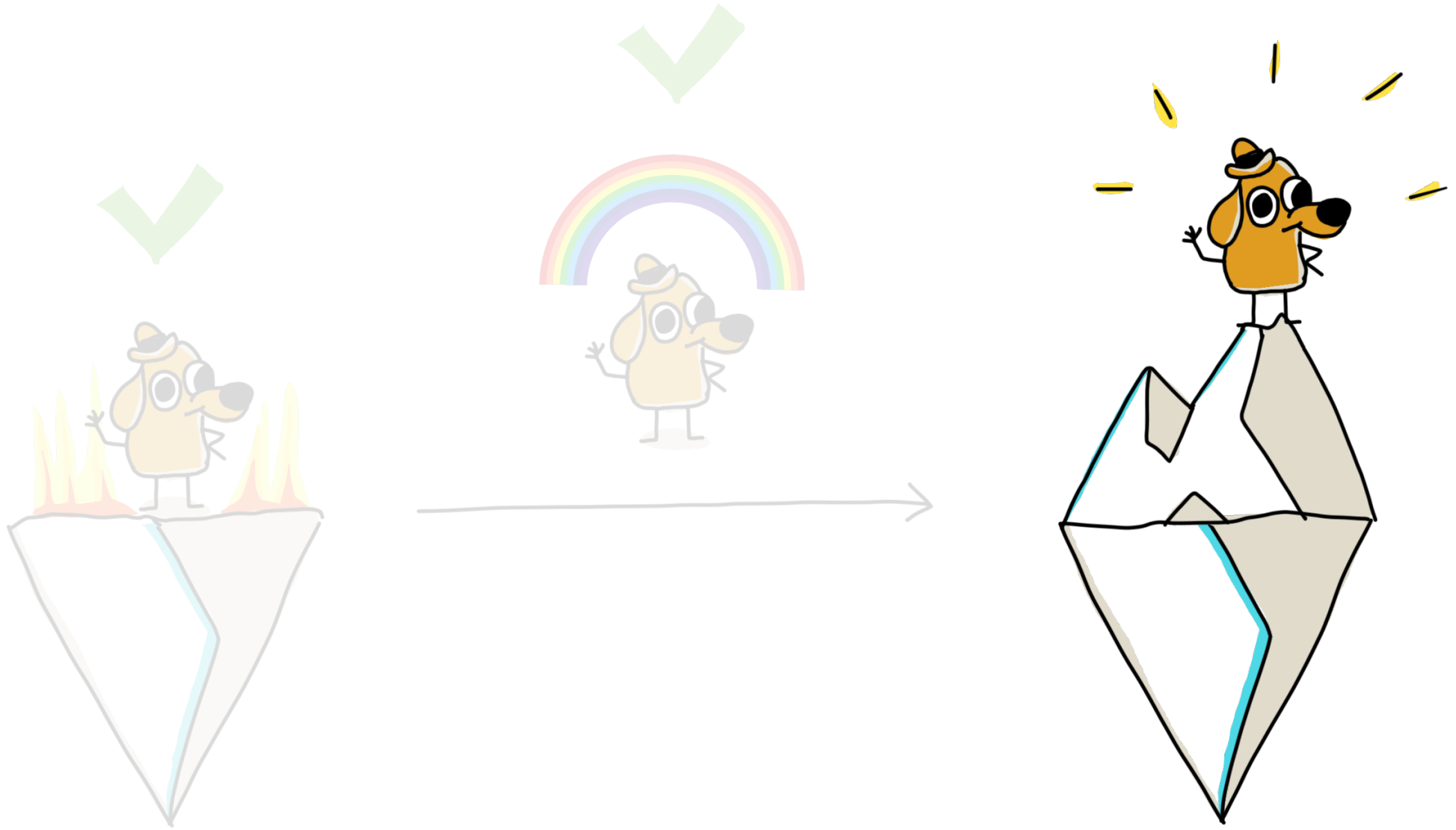

Drawings are created by © sievax.be. Do not reproduce without mentioning @ sievax.be

# DATA CULTURE

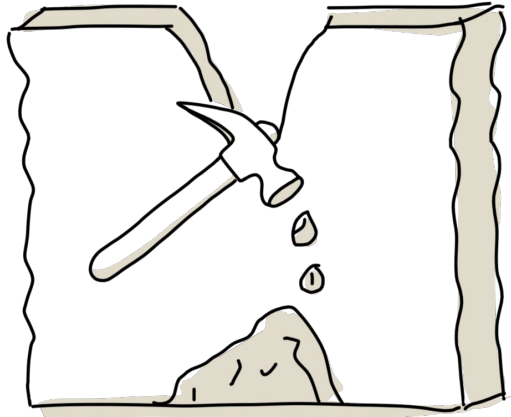

BREAKING SILO'S

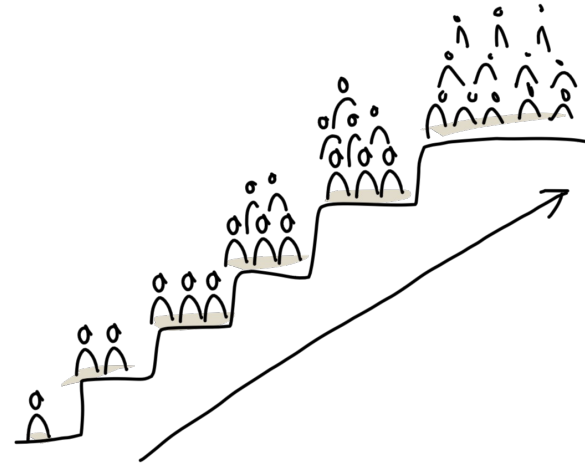

GROW TOGETHER

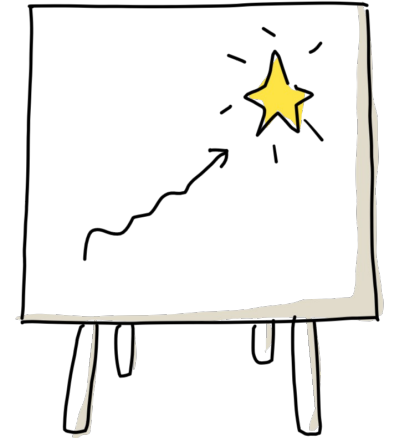

VISUAL THINKING

# DATA CULTURE

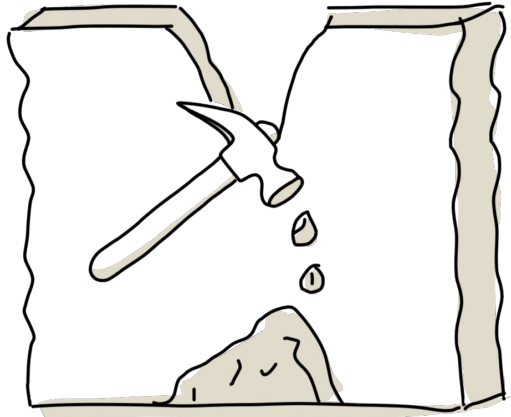

BREAKING SILO'S

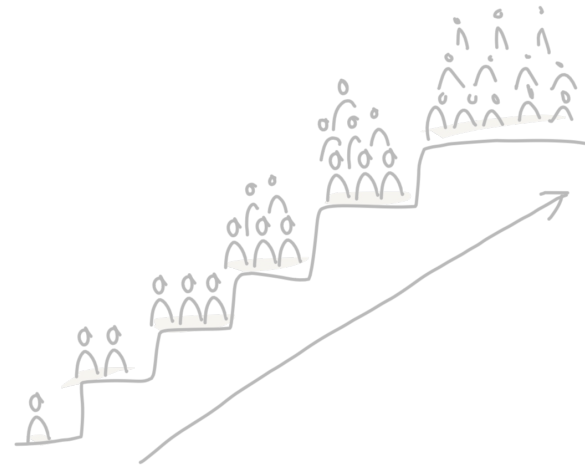

GROW TOGETHER



VISUAL THINKING

DATA PRODUCER  
STRATEGY

DATA CONSUMER  
STRATEGY

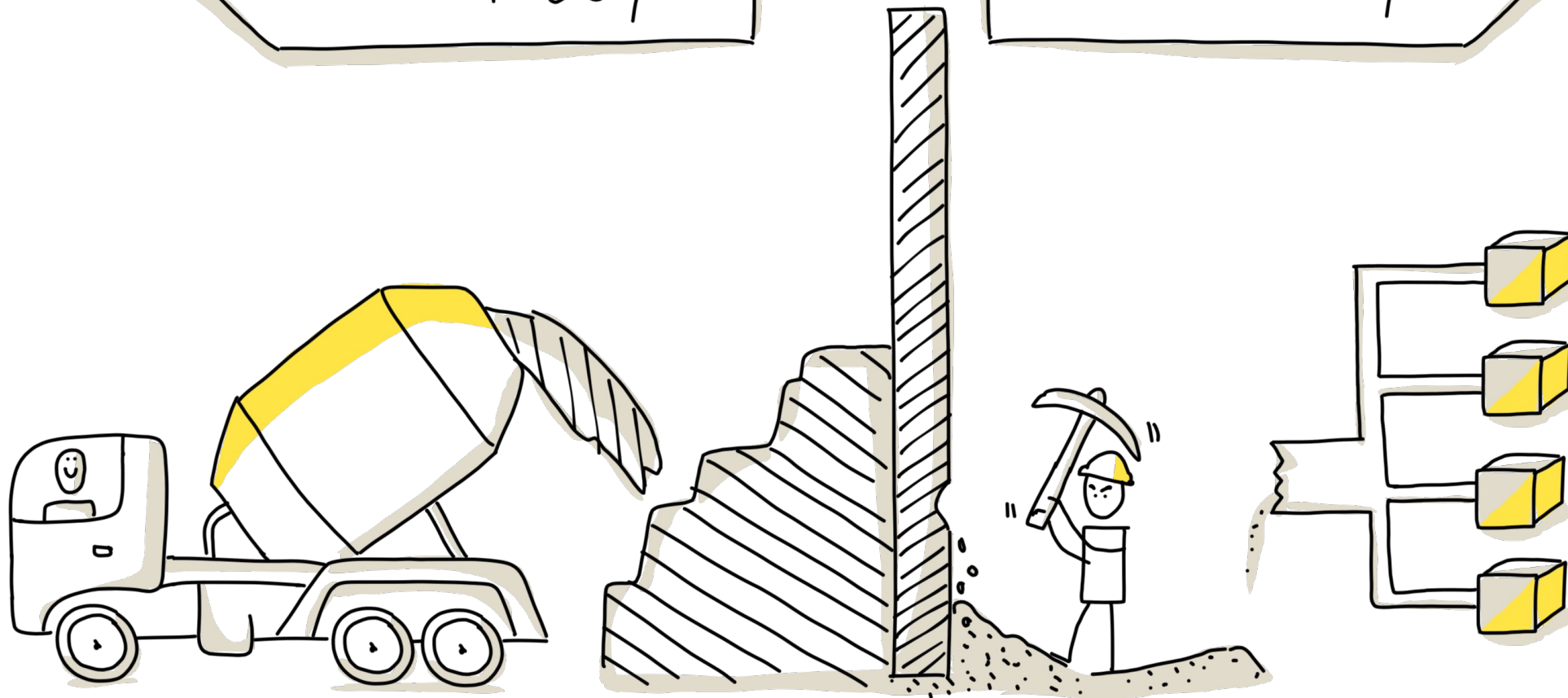

# CHANGING DATA CULTURE

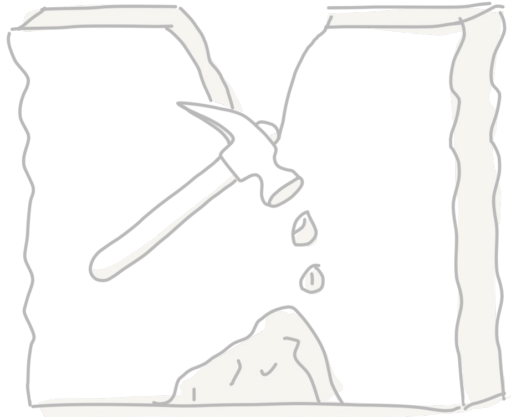

BREAKING SILO'S

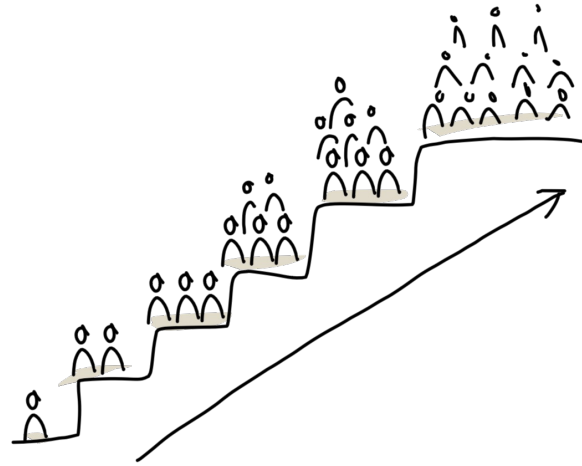

GROW TOGETHER



VISUAL THINKING

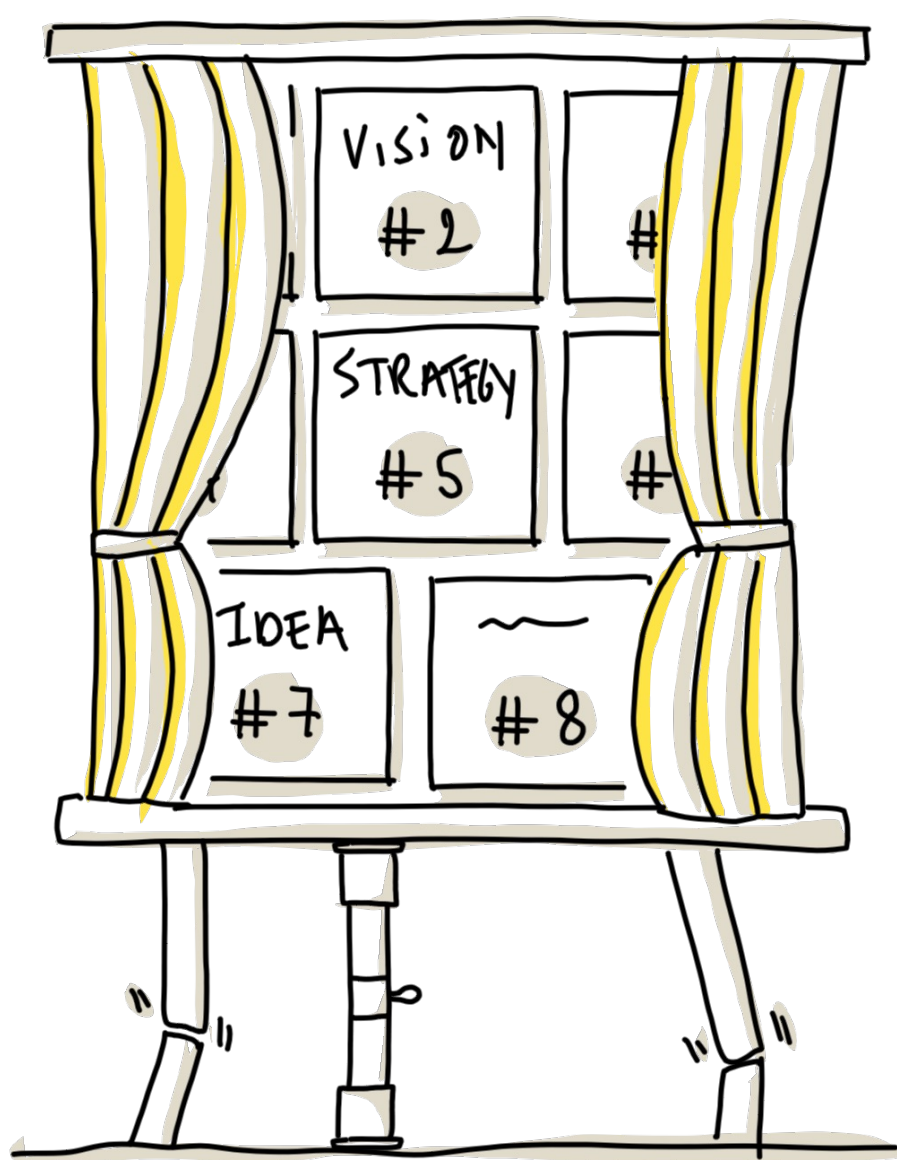

SLIDES

DATA & AI  
FOUNDATIONS

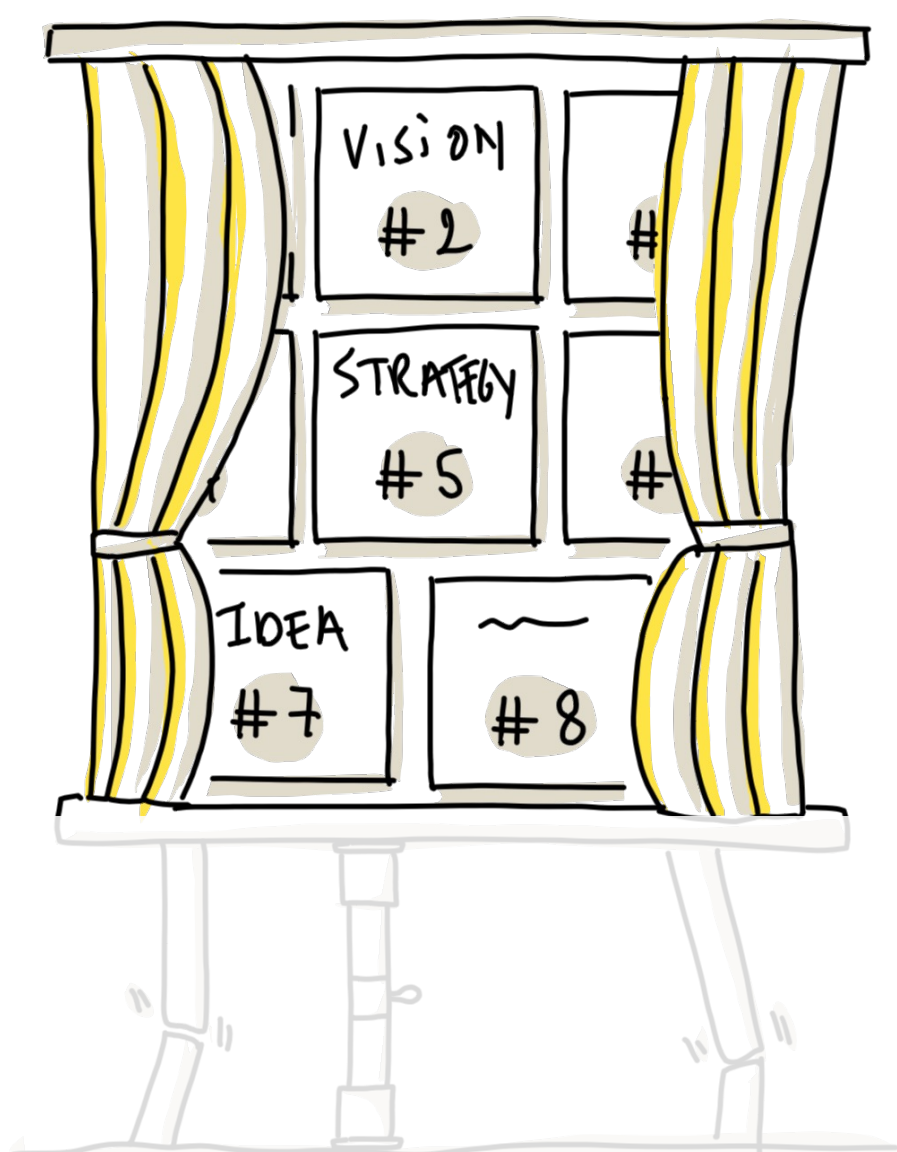

SLIDES

DATA & AI  
FOUNDATIONS

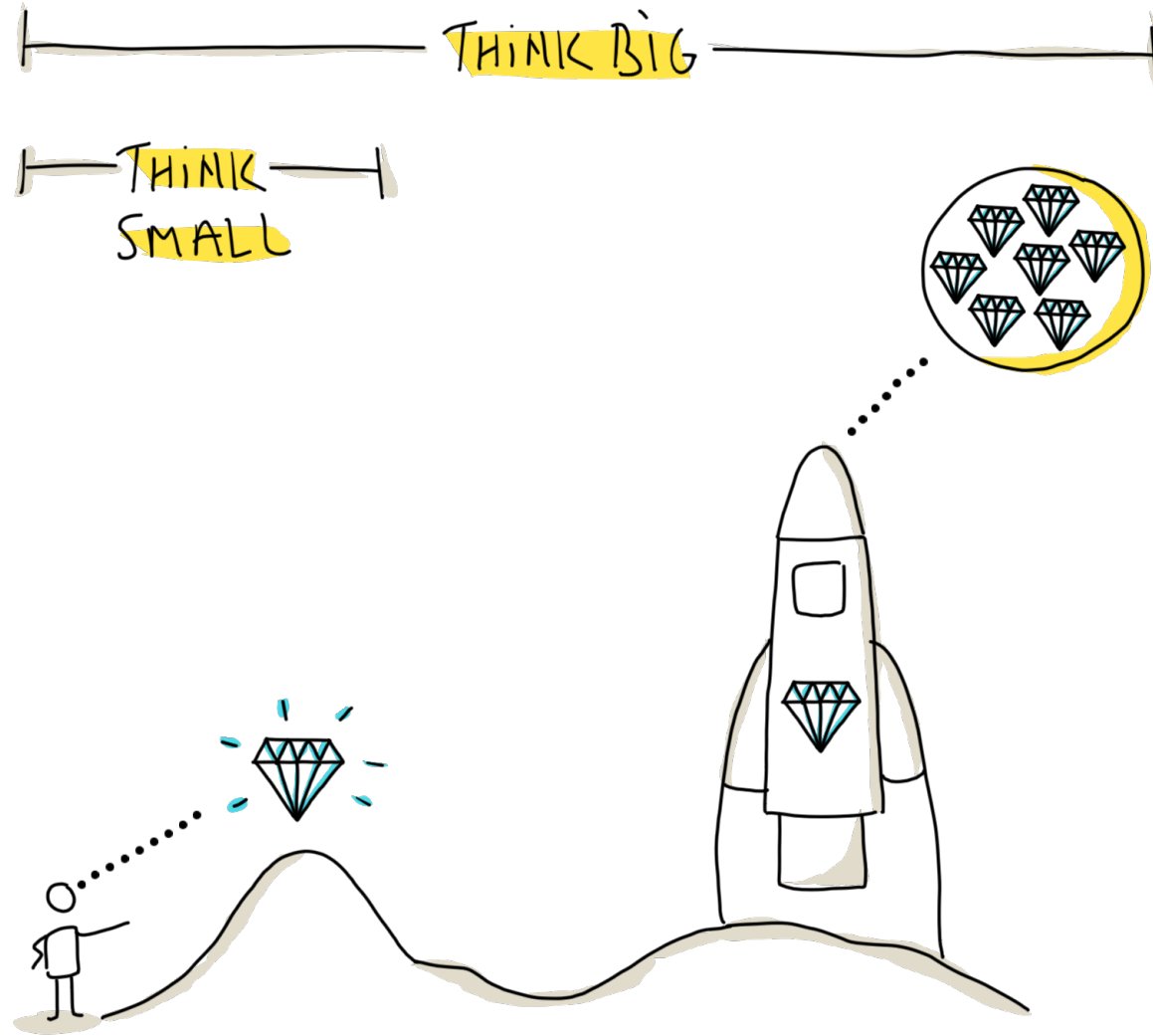

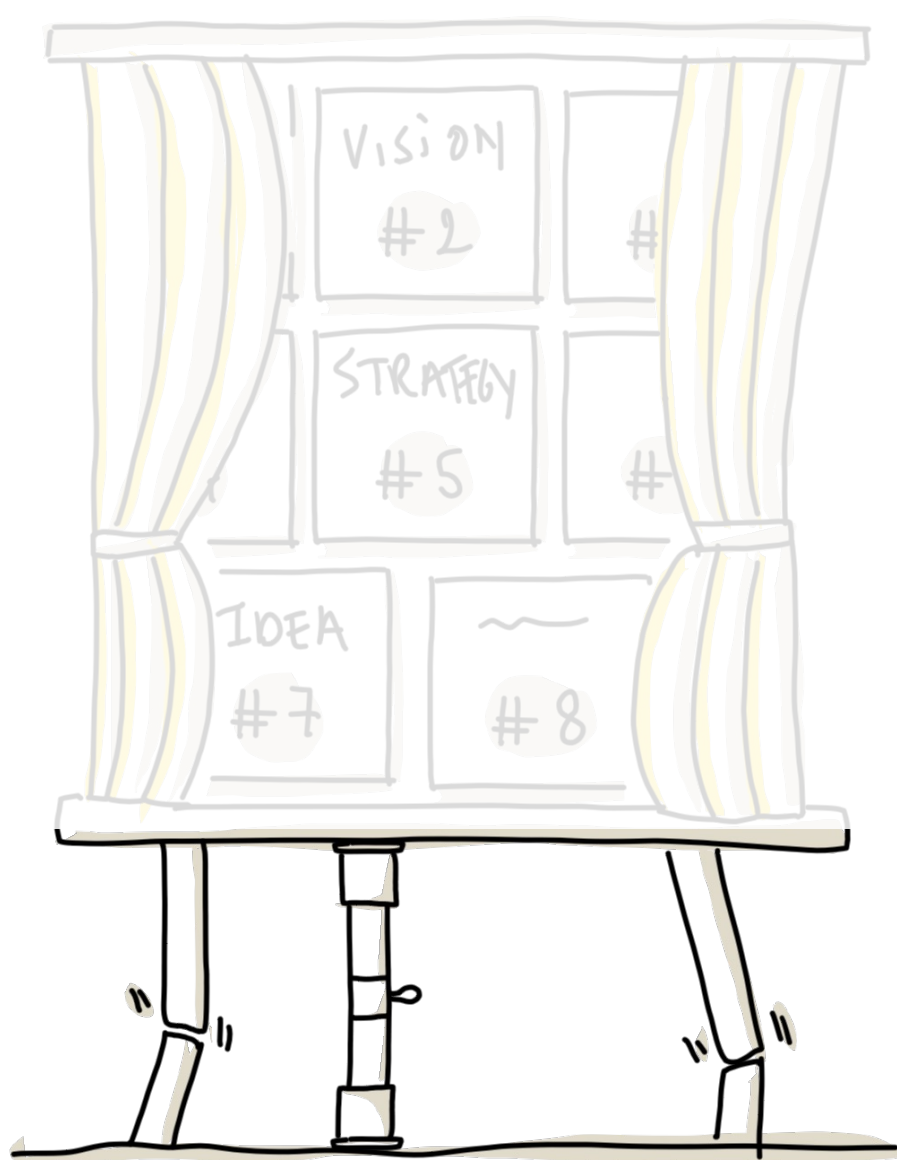

SLIDES

DATA & AI  
FOUNDATIONS

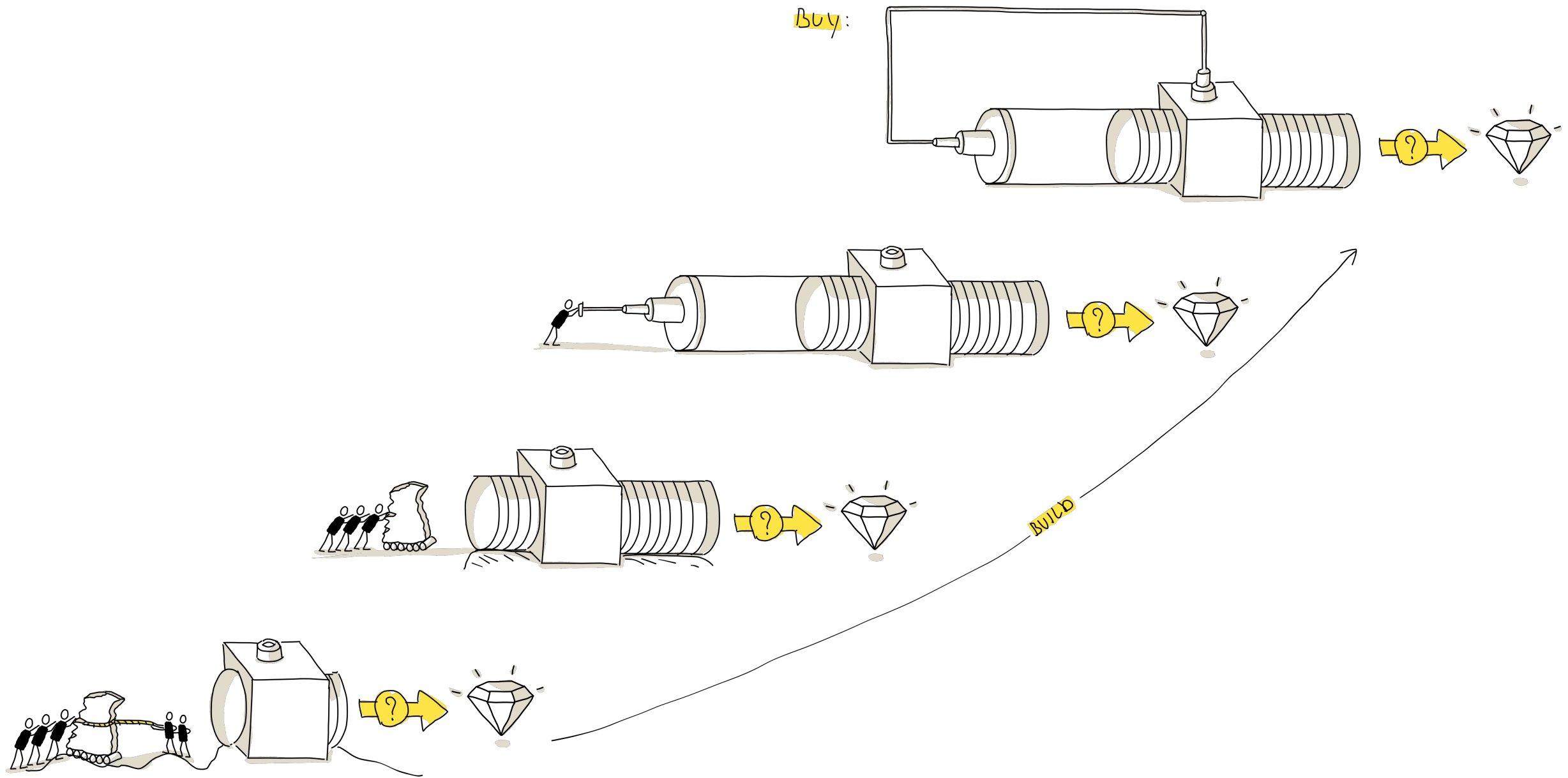

# CHANGING DATA CULTURE

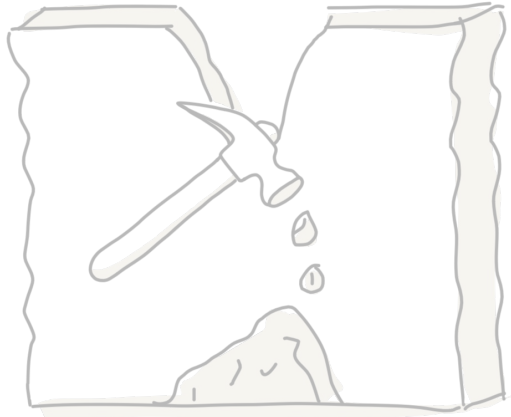

BREAKING SILO'S

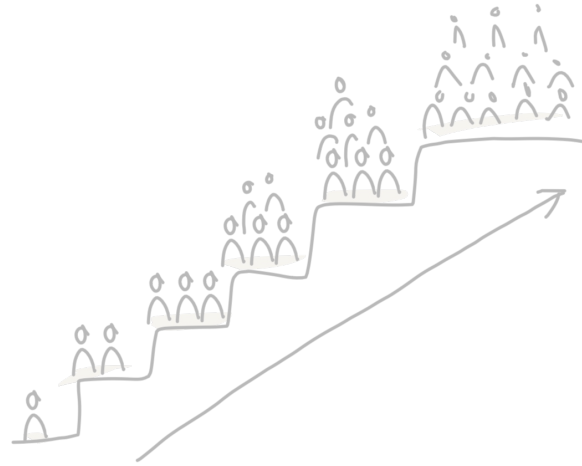

GROW TOGETHER

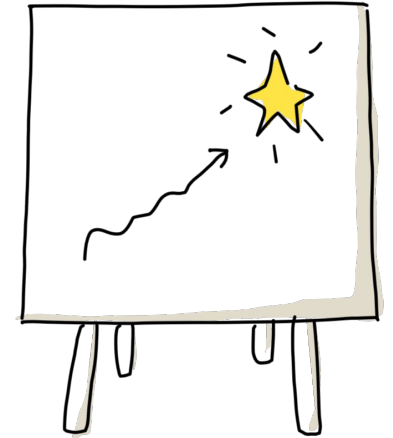

VISUAL THINKING

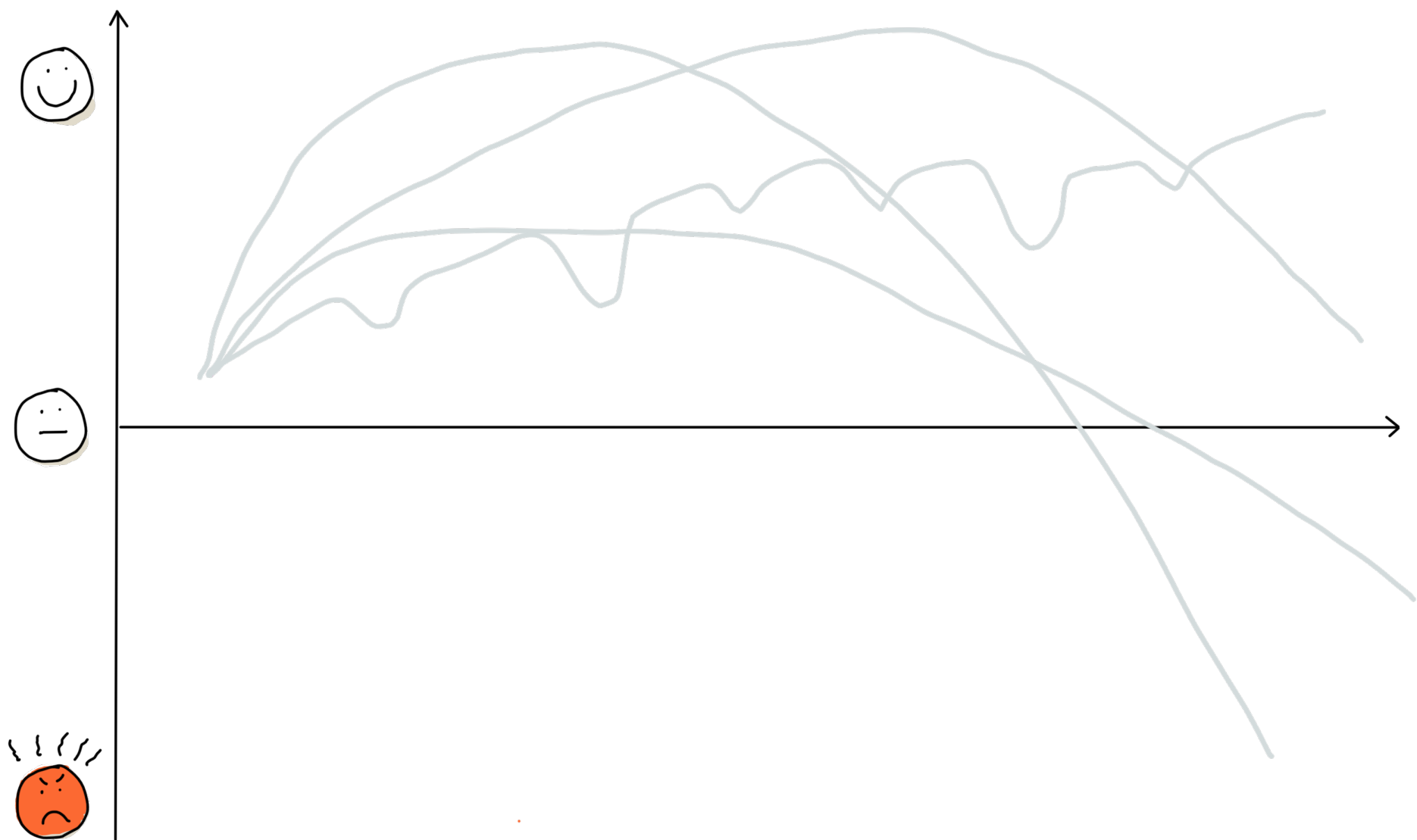

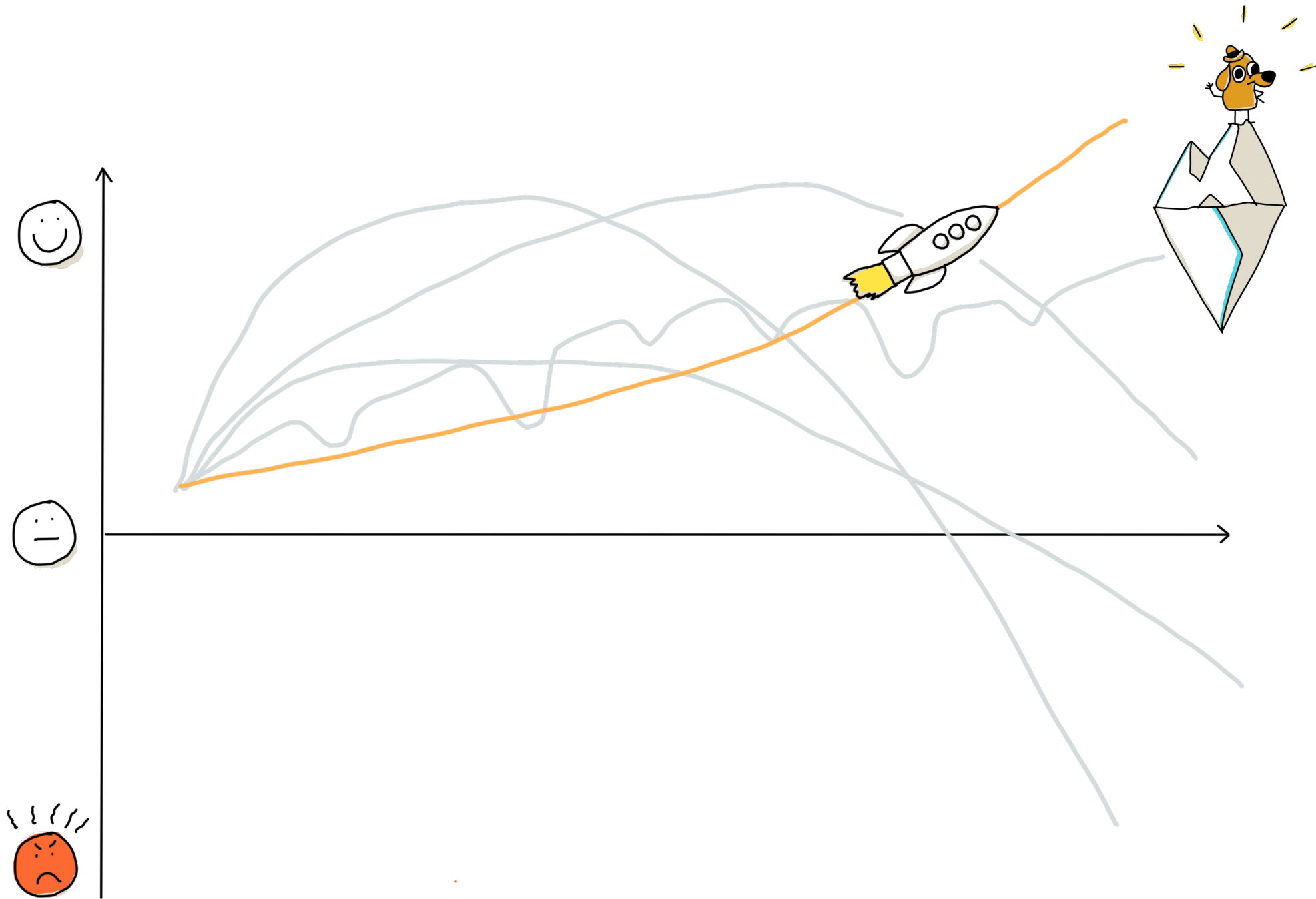

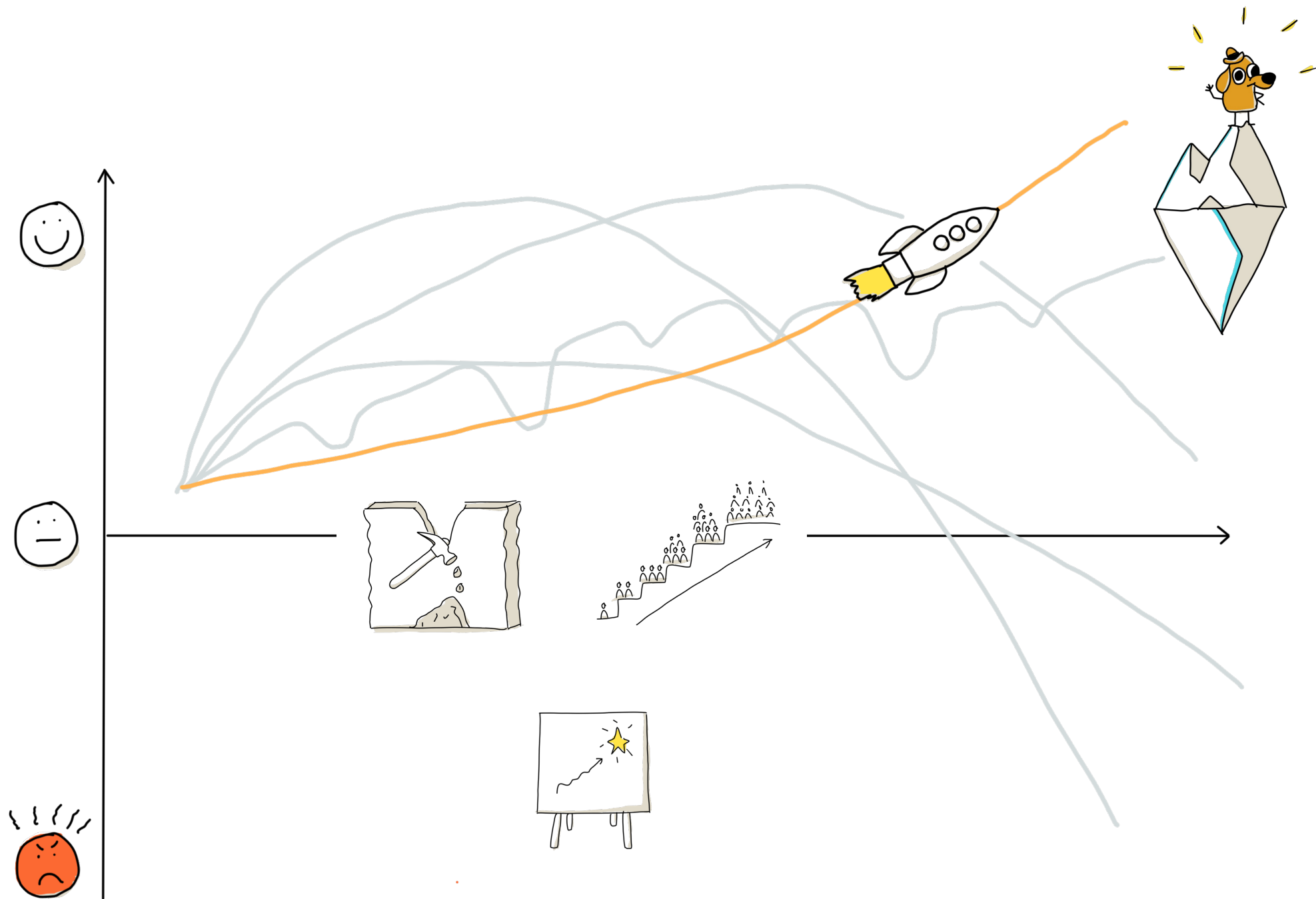





# Jan Meskens

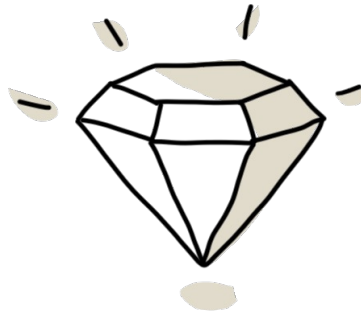

Data and AI Strategy  
Consultant

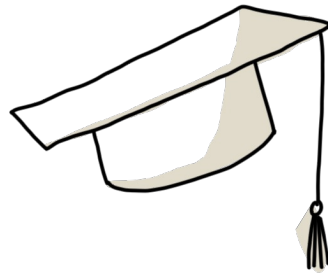

Keynote Speaker,  
Lecturer and Trainer



Founder and Manager  
of Sievax

# Download Slides:



[sievox.be/202412-savaco-seminars](https://sievox.be/202412-savaco-seminars)

## Questions?



[linkedin.com/in/janmeskens](https://linkedin.com/in/janmeskens)



[medium.com/@meskensjan](https://medium.com/@meskensjan)



[www.sievax.be](https://www.sievax.be)

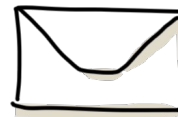

[jan@sievax.be](mailto:jan@sievax.be)